

Manual No: 503010100002  
REV: B  
May 2023  
Translated version

# Operation Manual

---

AB10ERJN/AB320ERJN



CE   EAC GB

**SINOBOOM**





## **WARNING**

**Operating, servicing and maintaining this vehicle or equipment can expose you to chemicals including engine exhaust, carbon monoxide, phthalates and lead, which are known to the State of California to cause cancer and birth defects or other reproductive harm. To minimize exposure and avoid breathing exhaust, do not idle the engine except as necessary, service your vehicle or equipment in a well-ventilated area and wear gloves or wash your hands frequently when servicing. For more information, go to: [www.P65warnings.ca.gov](http://www.P65warnings.ca.gov).**

**For disposal, please comply with local regulations.**

**SINOBOOM**



**星邦智能**

**星邦**

All of the above are registered trademarks of **Hunan Sinoboom Intelligent Equipment Co., Ltd.**

## **Contact us:**

**Website:** [www.sinoboom.com.cn](http://www.sinoboom.com.cn) / [www.sinoboom.com](http://www.sinoboom.com)

**Sales Tel:** 400-601-5828/0086-0731-87116222

**Service Tel:** 400-608-1289/0086-0731-87116333

**E-mail:** [info@sinoboom.com](mailto:info@sinoboom.com)/[sales@sinoboom.com](mailto:sales@sinoboom.com)

**Address:** No.128, East Jinzhou Avenue, Ningxiang High-tech Industrial Park, Changsha, Hunan, China

**Postal code:** 410600

**Copyright**©Hunan Sinoboom Intelligent Equipment Co., Ltd.

Hunan Sinoboom Intelligent Equipment Co., Ltd. retains the right of final interpretation of the manual.

# To Users

Thank you for choosing and using the machine of **Hunan Sinoboom Intelligent Equipment Co., Ltd.**

Use this machine only to transport tools to work locations and for performing tasks on the work platform. Only authorized personnel who have received appropriate training on MEWP can operate this machine. Before using the machine, carefully read and fully understand this manual and strictly follow its relevant instructions. Different countries, regions or governments may have different regulations for the operation of the machine, which may conflict with the manual, and in such case, the stricter operation regulations should be followed. Our company will not be liable for any adverse consequences arising from the failure to operate and use the machine in accordance with this manual or relevant regulations.

This manual provides necessary safety precautions and operation instructions for users. This manual covers the basic configuration information of one or more models. Please refer to those information applicable to your machine model. Consider this manual as a part of the machine, and always keep the manual with the machine. Without the written permission of Sinoboom, do not copy, spread, sell or alter the manual.

Due to continuous improvement and upgrading of product design and different product models covered, some charts and texts in the manual may be not applicable to your machine. Our company reserves the right to revise the manual due to technical improvement, and the manual is subject to change without further notice. Please contact Sinoboom or its authorized agent for the latest manual.

Please go to [www.sinoboom.com.cn](http://www.sinoboom.com.cn) to download your desired Operation Manual, Maintenance Manual and Parts Manual.

If you have any questions, contact **Hunan Sinoboom Intelligent Equipment Co., Ltd.**



# Applicable Models

The manual is applicable to machines with the following models and serial numbers:

Model	Metric Trade ID	Imperial Trade ID	Serial No.
AB10ERJN	AB10ERJN	AB320ERJN	0301000108 to present

**Note:**

- Check the machine model and serial number on the machine nameplate, and whose position can be found in the **Diagram of Decals Positions** section of the Operation Manual.
- Product model is indicated on the nameplate for distinction of products with different main parameters.
- Product trade identification is indicated on marketing materials and machine decals for distinction of products with different main parameters, and can be classified as metric type and imperial type: the metric trade identification is applicable to the machines for countries/regions using metric system or as specially required by customers; the imperial trade identification is applicable to the machines for countries/regions using imperial system or as specially required by customers.



# CONTENTS

<b>1</b>	<b>Safety Warning Symbols and Signs .....</b>	<b>1</b>
<b>2</b>	<b>Important Safety Rules .....</b>	<b>5</b>
2.1	General .....	5
2.2	Preparing for Operation .....	5
2.3	Operation Safety .....	6
2.4	Towing, Hauling and Lifting Safety .....	12
2.5	Maintenance Safety .....	13
<b>3</b>	<b>Responsibilities of Relevant Parties .....</b>	<b>17</b>
3.1	Owner's (or Lessor's) Responsibilities .....	17
3.2	Employer's Responsibilities .....	17
3.3	Trainer's Responsibilities .....	17
3.4	User's Responsibilities .....	17
<b>4</b>	<b>Technical Parameters .....</b>	<b>19</b>
4.1	Machine Specifications .....	19
4.2	Movement Speed .....	21
<b>5</b>	<b>Pre-operation Inspection .....</b>	<b>23</b>
5.1	Machine Components .....	24
5.2	Machine Positions .....	25
5.3	Pre-start Inspection .....	25
5.4	Functional Test .....	26
<b>6</b>	<b>Controllers and Indicators .....</b>	<b>29</b>
6.1	Turntable Controller .....	29
6.2	Turntable display .....	31
6.3	Platform Controller .....	32
<b>7</b>	<b>Operation Instructions .....</b>	<b>35</b>
7.1	General .....	35
7.2	Stability .....	35
7.3	Gradeability .....	37
7.4	Diagram of Working Envelope .....	38
7.5	Charging the Battery .....	38
	Harness Connection .....	39
	Charging Display .....	40
7.6	Turntable Rotation .....	40
7.7	Traveling .....	41
7.8	Boom Movements .....	42
7.9	Platform Movements .....	43
7.10	Auxiliary Power .....	43
7.11	Transportation and Lifting .....	44
7.12	Storage .....	45
<b>8</b>	<b>Emergency Procedures .....</b>	<b>47</b>
8.1	Reporting Accidents .....	47
8.2	Emergency Operation .....	47
8.3	Emergency Lowering .....	47
8.4	Emergency Towing .....	47
8.5	Override Function .....	48
<b>9</b>	<b>Decals Diagram .....</b>	<b>49</b>
<b>10</b>	<b>Maintenance .....</b>	<b>53</b>
10.1	Lubrication .....	53
10.2	Oil Requirements .....	54
10.3	Tire Assembly .....	55
	Check Wheel Fasteners .....	55
	Replacement Requirements .....	56
	Replace Tires .....	56
10.4	Inspection and Preventative Maintenance Schedule .....	57
	Pre-delivery Inspection .....	57

Pre-operation Inspection .....	57
Frequent Inspection .....	57
Annual Machine Inspection .....	57
Preventive Maintenance .....	58
Responsible Persons and Quali- fications for Performing Inspection and Maintenance .....	58
Inspection and Preventative Main- tenance Schedule .....	58

## **11 Options ..... 63**

11.1 Secondary Guarding .....	63
Device Components .....	64
Installation and Removal .....	65
Instructions for Use .....	65
Harness and Schematic Diagram....	66
11.2 Pipe Cradle .....	71
Parts List.....	71
Installation and Removal .....	72
Instructions for Use .....	73
11.3 Panel Cradle .....	73
Parts List.....	74
Installation and Removal .....	75
Instructions for Use .....	76
11.4 Platform Mesh .....	76
Parts List.....	77
Installation and Removal .....	79
Instructions for Use .....	81

# 1 SAFETY WARNING SYMBOLS AND SIGNS

The safety warning symbols used on the machine and in the manuals have the following meanings:



Safety warning symbol. This symbol is used to alert you to potential hazards. Please observe all safety instructions that follow the symbol to avoid possible injuries.

## DANGER

Indicates an imminently hazardous situation that, if not avoided, will result in death or serious injury.

## WARNING

Indicates an imminently hazardous situation that, if not avoided, could result in death or serious injury.

























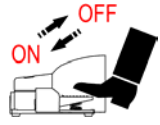



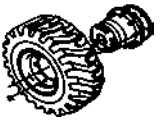
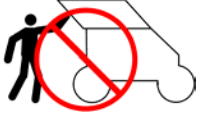

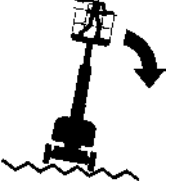
## CAUTION

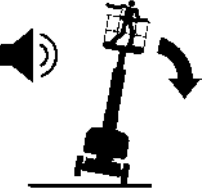
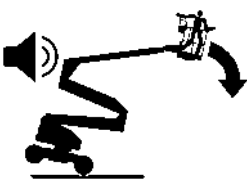

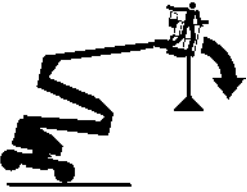

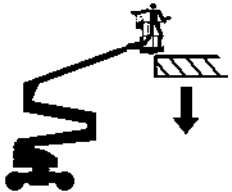
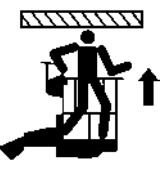







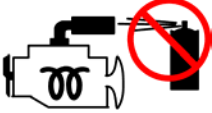

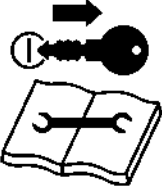

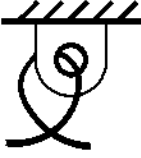

Indicates an imminently hazardous situation that, if not avoided, could result in minor or moderate injury.

## NOTICE

Indicates information directly or indirectly related to personal safety, machine damage, or property loss.

The safety signs used on the machine and in the manuals have the following meanings:

 Read maintenance manual	 Anchor point only for 1 person	 Wind speed	 Chemical burns hazard	 Wedge the wheel
 Read operation manual	 Add lubricant	 Crushing hazard- Please wear work shoes	 Danger of hot, high-pressure fluid sprays	 Wind
 Noise level	 Burns hazard	 Keep a safe distance from high temperatures	 Pull out-ON Press-OFF	 Alarm sounds
 Depress-ON Release-OFF	 Hydraulic oil level-low level	 Hydraulic oil level-high level	 Temperature	 Replace with tires of the same specification
 Only trained maintenance personnel can access the compartment	 Electrocution hazard on platform	 Electrocution hazard on the ground and platform	 Tipping hazard-Avoid uneven ground	 Tipping hazard-Avoid uneven ground
 Tipping hazard-Never use machine in strong, gusty wind	 Tipping hazard-Never use machine in strong, gusty wind	 Tipping hazard-Never push or pull objects outside platform	 Tipping hazard-Never suspend objects from platform	 Tip-over hazard-Never place ladders and scaffolding on platform
				

Collision hazard-Keep extended platform away from obstacles below when lowering platform	Collision hazard-Keep head away from overhead obstacles when raising platform	Crushing hazard-Keep hands away from overhead obstacles when raising platform	Fall hazard-Never climb on guardrails of platform	Fall hazard-Never climb on boom
 Keep away from rotating platform	 Engine preheating explosion hazard	 Never use ether or other starting additives for machines with glow plug	 Fuel explosion hazard	 Wear protective clothing and glasses
 Only professional maintenance personnel can perform maintenance	 Side force	 Electrocution hazard	 Battery explosion hazard	 No fire
 No smoking	 Lifting point	 Lashing point	 Tire-to-ground load	 Hydraulic oil filler
 Platform carrying capacity	 Do not use damaged cords	 Tool or weight	 Fast/high speed	 Slow/low speed
 Horn				

**This Page Intentionally Left Blank**

# 2 IMPORTANT SAFETY RULES

## 2.1 GENERAL

This chapter briefly describes the precautions that must be followed for safe and correct operation and maintenance of this machine. To ensure safe use and proper operation of the machine, the operator must perform routine maintenance on the machine in accordance with the Operation Manual and Maintenance Manual. In addition, the machine must be regularly maintained and serviced by a qualified service technician according to the instructions provided in the Maintenance Manual.

Please first find out the local regulations regarding MEWP and related operations. Different countries, regions or governments may have related operation regulations that are conflict with this manual, and in such case, the stricter operation regulations should be followed. If you have any questions about safety, training, inspection, maintenance, purposes and operation of the machine, please contact Hunan Sinoboom Intelligent Equipment Co., Ltd.

Sinoboom could not have foreseen all the dangers that may arise in relation to this machine, so all relevant parties should pay attention to safety seriously.

### WARNING

**Failure to follow the operating instructions and safety rules in this manual may result in machine damage, property loss, and personal injury.**

## 2.2 PREPARING FOR OPERATION

### Operator's Training and Knowledge Requirements

Before operating this machine, the operator should read, understand and comply with all applicable regulations and requirements of employers, local authorities and governments related to the use of the machine.

Before operating this machine, the operator should carefully read and fully understand this manual, and accept professional training based on the Operation Manual and obtain the qualification to operate the machine before operating the machine independently. The training content shall include, but not be limited to, the following:

- Various warnings and operation instructions on the machine and the Operation Manual

- Pre-start inspection
- Factors affecting the stability of the machine
- Common hazards and how to avoid them
- Workplace inspection
- Functions and related knowledge of all controls, including emergency control
- Use of personal protective equipment appropriate to the work task, workplace, and environment
- Safe operation
- Transportation
- How to avoid unauthorized use

### Workplace Inspection

Before and during the operation of the machine, the user must pay attention to the hazards and take preventive measures to avoid hazards in the work area. Unless with the written permission of Hunan Sinoboom Intelligent Equipment Co., Ltd., this machine shall not be used in the following conditions:

- Steep slopes or caves
- Ground with protrusions, obstacles, or debris
- Insecure or slippery surfaces
- Surfaces not sufficient to support the machine (machine weight + platform load)
- Trucks, trailers, rail cars, ships or other equipment
- Dangerous locations
- Places with overhead electric wires, cranes or other potential obstacles
- In gusts, strong winds, or lightning weather
- Unauthorized persons
- Other places where unsafe conditions may occur

### Machine Inspection

Make sure to complete all checks in strict accordance with the steps in the **Pre-operation Inspection** section of this manual before operating the machine:

- **Pre-start inspection** : Ensure that all components are not loosening, missing or altered, and are securely fixed, without visible damage, leakage or excessive wear, etc., and all parts are kept in their original positions and working normally; make sure that all fluid levels, battery level, etc. are appropriate; ensure that the maintenance work has been

completed in accordance with the maintenance requirements specified in the Maintenance Manual.

- **Decals Inspection** : Ensure that all decals and nameplates are not missing and damaged and are clearly visible.
- **Functional check** : Make sure that all functions of the machine are working properly.





## WARNING

Without the written permission of Hunan Sinoboom Intelligent Equipment Co., Ltd., it is forbidden to alter or modify the machine.

## 2.3 OPERATION SAFETY



General

 <b>WARNING</b>	
	<ul style="list-style-type: none"> <li>• This machine shall only be used to transport tools to work locations and for performing tasks on the work platform, and should not be used for other purposes.</li> <li>• Operators shall use personal fall protection equipment (PFPE) while operating the machine. If the use of PFPE by persons on the platform is required in the workplace or user rules, the PFPE shall be inspected and used in accordance with the PFPE manufacturer's instructions and applicable government requirements.</li> <li>• The operator should concentrate on work during the operation of the machine. The use of mobile phones, wireless walkie-talkies, etc. may distract the operator and affect the safe operation of the machine, so the operator should completely stop the machine before using such devices.</li> <li>• Remove all rings, watches and other accessories before operating the machine, do not wear loose clothing, and do not let long hair hang loosely.</li> <li>• People who have consumed alcohol or taken medicine, those who are overtired or depressed, those who have heart disease or other diseases such as high blood pressure or epilepsy, those who are physically unwell, and those who are afraid of heights are prohibited from operating the machine.</li> <li>• Do not operate a damaged or malfunctioning machine. In case of any failure, stop the machine immediately, have it tagged, and contact the manufacturer or relevant department.</li> <li>• Never disassemble, modify or retrofit the machine or its parts.</li> <li>• Never disable any safety devices of the machine.</li> <li>• Never place items on the platform guardrails.</li> <li>• Never push the control switch or joystick through the neutral position and directly to the opposite</li> </ul>

 <b>WARNING</b>
<p>direction. Before pushing the switch to the next function position, move it back to the neutral position and stop, and then move it with slow and uniform force to perform the next function.</p> <ul style="list-style-type: none"> <li>• Unless in case of emergency, it is forbidden to perform operations from the ground if any person is still on the platform.</li> <li>• When there are two or more operators on the platform, all operations of the machine must be conducted by one person.</li> <li>• Always operate the machine in well-ventilated conditions to avoid carbon monoxide or nitrogen oxide poisoning.</li> <li>• Before leaving the machine, the platform should be completely lowered and all power should be cut off.</li> </ul>

## Electrocution Hazard

⚠ **WARNING**

- This machine is not insulated and not equipped with electrocution protection function.
- Do not use this machine in thunder and lightning or rainstorm weather. In the event of thunder and lightning or rainstorm while operating the machine, immediately fully lower the platform in a safe and stable position and cut off all power sources, to avoid personal injury or machine damage.
- Comply with the national or regional provisions about minimum safety distance from live conductors. In absence of such provisions, comply with [Page 8, Table 2-1 Minimum Safe Distance](#), to keep a minimum safety distance from electric wires, electrical equipment or any live (bare or insulated) components. The minimum safety distance shall be determined with machine movement, electric wire swinging or drooping considered.
- If rated insulating barriers appropriate to the voltage of electric wire are installed, the minimum safety distance can be shortened. Such barriers cannot be taken as a part of the machine or fixed on the machine. Reducing the minimum safety distance with insulating barriers must comply with relevant national or regional regulations.
- Do not use the machine as a ground wire during welding and polishing operations.

Table 2-1 Minimum Safe Distance

Voltage (Phase to Phase, kV)	Minimum Safe Distance
0-50	3.05m (10ft)
50-200	4.60m (15ft)
200-350	6.10m (20ft)
350 -500	7.62m (25ft)

Table 2-1 Minimum Safe Distance(Continued)





Voltage (Phase to Phase, kV)	Minimum Safe Distance
500 -750	10.67m (35ft)
750 -1000	13.725m (45ft)

⚠ **DANGER**

Do not operate the machine or transport personnel with the machine in prohibited live areas.

## Tripping and Fall Hazards

⚠ **WARNING**

- Before operating the machine, ensure that the platform guardrails are properly installed and that the platform gates are closed and properly secured.
- Operators on the platform must wear the safety belt properly and secure the safety belt to the specified fixing point with hooks. Each fixing point shall only be used by one person.
- Only enter and exit the platform through the platform gate, never through the boom tube, and extra care should be taken. Before entering and exiting the platform, make sure the platform is fully lowered. When entering and exiting the platform, face the platform and maintain “three-point contact” with the machine with both hands and one foot or both feet and one hand.
- Feet must stand steadily on the platform floor at all times. It is forbidden to sit, stand or climb on the platform guardrails.
- Never use ladders, boxes, steps, boards, or similar items on the platform to extend the accessible range.
- Do not allow oil, sludge or other slippery substances to remain on work shoes and platform floor.
- Keep the platform floor unobstructed.

**Tipping Hazard**

 **WARNING**



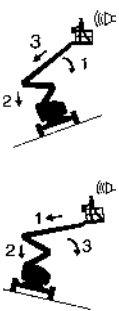

- Before driving the machine onto any ground, bridges, trucks and other surfaces, check if the loading capacity of these surfaces is sufficient to support the machine (machine weight + platform load). Never drive the machine on surfaces or edges that are not supported or under-supported.
- Operators must know about the ground conditions in the work area before work.
- Do not use the machine on moving surfaces or vehicles.
- The total weight of personnel, devices and materials on the platform shall not exceed the maximum carrying capacity of the platform, and all loads shall be kept within the specified range of the platform.
- The machine can only be driven at low speed on slopes.
- It is forbidden to drive the machine on slopes, steps or arched surfaces that exceed the maximum allowable climbing angle of the machine.

 **WARNING**



- Do not use the tilt alarm as a horizontal indicator. The tilt alarm on the platform will sound only when the machine is heavily tilted.
- If the tilt alarm sounds when the machine drives up a slope, lower the boom as per the following instructions and move the machine to firm and level ground. Make sure not to rotate the boom while lowering it.
  1. Lower the main boom;
  2. Lower the articulated boom;
  3. Retract the telescopic boom.
- If the tilt alarm sounds when the machine drives down a slope, lower the boom as per the following instructions and move the machine to firm and level ground.

 **WARNING**



- Make sure not to rotate the boom while lowering it.
  1. Retract the telescopic boom;
  2. Lower the articulated boom;
  3. Lower the main boom.
- When the platform is raised, do not drive the machine on uneven or soft surfaces, or slopes that exceed the maximum allowable climbing angle of the machine, or in other dangerous conditions.
- The boom can only be raised or extended when the machine is on solid, flat ground.
- When the machine is traveling on uneven ground, or on other rough ground with gravel, or near cave openings, steep slopes, etc., maintain a distance of at least 0.6m (2ft) from the potentially dangerous objects, and reduce the speed.
- Do not push or pull any objects outside the platform.
- Never push or pull other equipment or objects with the platform or boom.
- Do not place or attach any suspended load on or to any part of the machine.
- Do not place any load outside the perimeter of the platform.
- It is forbidden to use the machine as a hoist or crane.
- Never attach the machine or its parts to any adjacent objects.
- When one or more tires are off the ground, first evacuate all personnel and then stabilize the machine with cranes, hoists, forklifts, or other suitable equipment.
- Without the written authorization of the manufacturer, it is forbidden to modify, remove or install any parts, including counterweights, which may affect the safety and stability of the machine.
- Do not replace critical parts that affect the stability of the machine with parts of different weights or

**⚠ WARNING**

specifications. For example, the batteries, because they not only provide power, but also play the role of counterweight, which is essential to maintain the stability of the machine.

**⚠ WARNING**

- Do not operate the machine when the wind speed exceeds 12.5m/s (28mph). Please check the Beaufort wind force scale in [Page 10, Table 2-2](#). Factors that affect wind speed include: platform height, surrounding terrain, local weather. For example, the wind speed at high places may be much faster



**⚠ WARNING**

than those on the ground.

- Wind speeds might change at any time. The upcoming weather conditions, the time required to lower the platform, and ways to monitor current and potential wind conditions must always be considered.
- When operating the machine outdoors, do not carry items with a large surface area on the platform, do not cover the surface of the platform or load, and do not use other additional items to increase the surface area of the platform or load. Adding additional items will increase the area of the machine exposed to wind, and increasing the windward area will lead to reduced machine stability.





Table 2-2





BEAUFORT SCALE	WIND SPEED		DESCRIP-TION	LAND CONDITIONS
	METER/SECOND	MILE/HOUR		
0	0 ~ 0.2	0 ~ 0.5	Calm	Calm. Smoke rises vertically.
1	0.3 ~ 1.5	1 ~ 3	Light air	Direction of wind shown by smoke drift.
2	1.6 ~ 3.3	4 ~ 7	Light breeze	Wind felt on exposed skin. Leaves rustle.
3	3.4 ~ 5.4	8 ~ 12	Gentle breeze	Leaves and smaller twigs in constant motion.
4	5.5 ~ 7.9	13 ~ 18	Moderate breeze	Dust and loose paper rise. Leaves and smaller twigs in constant motion.
5	8.0 ~ 10.7	19 ~ 24	Fresh breeze	Smaller trees sway.
6	10.8 ~ 13.8	25 ~ 31	Strong breeze	Large branches in motion. Flags waving near horizontal. Umbrella use becomes difficult.
7	13.9 ~ 17.1	32 ~ 38	Near gale/ moderate gale	Whole trees in motion. Effort needed to walk against the wind.
8	17.2 ~ 20.7	39 ~ 46	Fresh gale	Twigs broken from trees. Cars veer on road.
9	20.8 ~ 24.4	47 ~ 54	Strong gale	Light structure damage.

**⚠ DANGER**

If the wind speed increases to exceed 12.5m/s (28mph) after the platform is raised, the platform should be retracted immediately, and then all power supplies should be cut off, and the machine should be stopped.

**Collision and Crush Hazards**

 **WARNING**

- All operators and other personnel in the work area must wear a qualified safety helmet.
- Keep all parts of the body within the perimeter of the platform during operation.
- Care should be taken at all times to avoid contact with stationary objects (buildings etc.) or moving objects (vehicles, cranes etc.) to prevent obstacles from hitting or interfering with operation controllers or operators on the platform.
- During operation, make sure to check the clearance and obstacles above, around and below the platform.
- While moving or operating the machine, pay attention to the line of sight and blind spots. In cases where the line of sight is obstructed, lookouts should be arranged.
- When the machine is moving, if the platform is about 2m (6.6ft) away from an obstacle, make sure to move the boom or platform to approach the obstacle, and do not drive the machine.
- Non-operators must be at least 1.8m (6ft) away from the machine while it is working.
- When the machine is working with the platform elevated, warn workers/non-workers not to work, stand or walk under the elevated boom or platform. If necessary, place barricades around the work area on the ground.
- Make sure there are no people and obstacles below the platform before lowering the platform.
- Do not place hands, arms, or other body parts near areas where they may be crushed.
- If the boom is not lifted by lifting equipment, do not work under the platform or boom.
- Make sure that other nearby operators working at height and on floors are aware that this MEWP is

 **WARNING**

working.

- Limit travel speed based on ground conditions, congestion, ground slope, location of people, and other factors.
- Find out the braking distance at all travel speeds. When traveling at high speed, reduce the travel speed before stopping.
- When traveling in confined or enclosed areas, or when reversing, do not engage the high speed gear.
- Before releasing the brake, the machine must be on a horizontal surface or secured.

## 2.4 TOWING, HAULING AND LIFTING SAFETY

### WARNING



- Unless in case of emergency situations, machine malfunction, power loss or loading/unloading, it is strictly prohibited to tow or drag the machine.
- The towing and dragging of the machine should follow local policies and road traffic laws.
- Before towing, hauling or lifting the machine, make sure that the boom is stowed, that the turntable is locked (or if equipped with turntable rotation pin, that the turntable rotation pin is locked), that there are no loose or unfixed parts on the machine, and that there are no tools on the platform.
- Only the lifting points/rigging lashing points on the chassis can be used to tow, haul or lift the machine. Ensure that the machine lifting points/rigging lashing points and their attached structures are intact and that the belt or rope to be used has sufficient load strength.
- When towing, hauling or lifting the machine, no people are allowed on the platform.
- Before loading/unloading the machine, ensure that the transport vehicle is parked on level ground, that the loading surface of the transport vehicle is sufficient to support the machine, and that the slope of the ramp used for driving the machine onto the trailer does not exceed the maximum climbing angle of the machine.
- When loading/unloading the machine, the transport vehicle must be secured to prevent it from moving.
- The wheels should be locked after the machine is loaded to prevent the machine from moving.
- The machine can only be lifted from the specific position with a forklift or crane with sufficient lifting capacity. Care should be taken

### WARNING

to prevent the machine from colliding with surrounding objects.

For towing and dragging procedures, refer to the **Emergency Traction** section of this manual. For transport and lifting procedures, please refer to the **Transport and Lifting** section of this manual.

### 2.5 MAINTENANCE SAFETY

#### Unsafe Maintenance Hazard

##### **WARNING**



- Before performing any adjustment or service operations, power off all control units and ensure that all moving parts are securely secured and free from accidental movement.
- Before performing any adjustment or service operations, ensure that the boom is stowed, and do not work under the raised platform/boom. If anyone needs to work under the raised platform/boom, the platform and boom must be supported with appropriate safety supports.
- When lifting or moving heavy parts of the machine, use equipment with sufficient capacity, and never place heavy objects in unstable positions after moving.
- When machine parts are lifted by other equipment, ensure that there are no people under and around the equipment.
- When striking the brass rod with a mallet, make sure to wear goggles.
- If you need to replace parts, use the original parts designated by Sinoboom.
- Do not wash the machine with water. The machine contains many electronic components such as solenoid valves and sensors, which may fail or work poorly after water ingress. If water washing is necessary, please turn off the main power switch firstly, and dry the machine thoroughly before turning on the power.
- Make sure the machine is turned off before using flushing equipment (such as high-pressure water gun) to clean the machine. It is forbidden to direct the water or vapor ejected from the flushing equipment at the electrical components, otherwise short circuit or electric shock may result.
- After maintenance, clean the spilled hydraulic oil thoroughly and do not spill the hydraulic oil on the ground.

 **WARNING**

- After maintenance, immediately wash any hydraulic oil on the skin.
- Waste hydraulic fluids, fuels, coolants and refrigerants should be recycled or disposed as per local regulations.

## High Temperature and High Pressure Hazards

 **WARNING**



- Some parts may have high surface temperature when the machine is running or after the machine has running for some time, which may cause burns through skin contact. Do not touch any hot parts!
- It is forbidden to repair or tighten hydraulic hoses or seals while the machine is live or when the oil system is under pressure.
- Before loosening or disassembling the hydraulic parts (especially the counterbalance valve on the cylinder), the hydraulic pressure of all hydraulic lines should be released and ensure that the hydraulic oil is completely cooled down.
- Disassemble the hydraulic components slowly to prevent the hydraulic oil from splashing and injuring people.
- It is forbidden to check the hydraulic leakage point by hand. Use a piece of cardboard or stiff paper to find leaks, and wear gloves to protect your hands from hydraulic fluid sprays.
- Do not operate the machine in case of hydraulic oil or air leaks. Oil or air leaked from the hydraulic system may penetrate and burn the skin.
- It is forbidden to plug leaking hydraulic oil by hand. If there is a leak, the pressure of the hydraulic system should be released first, and the maintenance should be carried out after the hydraulic oil has cooled down.
- If you are injured by ignoring the dangers of high temperature and high pressure, seek immediate medical attention. If treatment is not carried out immediately, serious complications can result.



**Welding and Polishing Operation Hazards**

 **WARNING**

-  Welding, grinding and polishing operations must follow the appropriate local safety operating procedures.
- Before performing welding, grinding and polishing operations, the machine should be powered off, and ensure that the wires or cables are connected correctly.
- Do not use the machine as a ground wire during welding and grinding operations.
- Always make sure that all power tools are completely placed within the perimeter of the platform. Do not hang the wires of power tools on the guardrail of the platform or in any work area outside the platform, or hang the power tools directly with wires.







**Fire and Explosion Hazards**

 **WARNING**

-  Do not operate the machine, charge the battery or refuel the machine in places where potentially flammable or explosive gases may be present.
-  Refueling and charging should be carried out in a well-ventilated place without flames, sparks, and other hazards that may cause fire or explosion.
- For machines powered by an engine, do not refuel the machine while the engine is running.
- Never spray ether into the engine with a glow plug (if the machine is equipped with an engine).
- Never touch the battery terminals or cable clamps with tools that can generate sparks.
- Only approved non-flammable cleaning solutions should be used on the machine.

**Battery Hazard**

 **WARNING**

-  Be sure to read and follow the battery manufacturer's recommendations on proper battery use and maintenance procedures.
-  Non-professionals should not repair and maintain the battery system, otherwise it may cause personal injury or damage to the battery system.
-  Non-professionals should not modify parameters, detection lights, etc. during the operation of the battery system, otherwise it may cause personal injury or damage to the battery system.
-  Always wear goggles, protective gloves and protective clothing, and remove all rings, watches and other accessories before servicing the battery. Contact with live circuits may result in death or serious injury.
-  Before replacing the battery, be sure to select an appropriate number of personnel and appropriate lifting methods.
-  It is forbidden to modify the battery system without approval to avoid serious accidents.
- When maintaining electrical components, the battery should be disconnected.
- Never connect tools or other metal objects between the two binding posts of the battery.
- The battery charger can only be connected to a grounded three-wire AC power outlet. Please make sure the charger is working properly before charging. Do not connect the battery directly into a power outlet.
- In the use of the battery, if there is any abnormal conditions such as heating, deformation, leakage, peculiar smell or smoke, the battery must be stopped from use immediately and such conditions must be reported to the relevant maintenance personnel in time.
- Batteries contain sulfuric acid and can produce explosive

 **WARNING**

mixtures of hydrogen and oxygen. Keep any materials (including cigarette/smoking materials) that can cause sparks or flames away from batteries to prevent explosion.

- Never touch the battery terminals or cable clamps with tools that can generate sparks.
- Never charge the battery in direct sunlight. The battery should be charged in a well-ventilated place.

**NOTICE**

- It is forbidden to place other objects and tools on the battery to prevent short circuit in the battery.
- It is forbidden to tap, throw or step on the battery, or hit it with sharp parts.
- Do not immerse the battery in water, acidic, alkaline or salty solutions, and protect the battery from rain.
- The battery should be fully charged immediately after each use of the machine, and then the machine power switch should be turned off.

 **CAUTION**



- Avoid battery acid spillage or contact with unprotected skin. If battery acid spills, use water mixed with bicarbonate (baking soda) to neutralize the acid. In case of contact with battery acid, rinse the acid off immediately with plenty of water and seek medical attention promptly.
- Always keep the battery upright. If the battery is placed on its side or diagonally, liquid may spill out of the battery.
- End-of-life batteries may cause danger, so please do not discard them at will. Please contact the battery recycling company if you need to scrap batteries.

**NOTICE**

*Battery over-discharge (continued use of battery with level of less than 10%) or battery under-voltage caused by long-term non-charging (battery with level of less than 10% not charged for more than three days), resulting in battery capacity attenuation and failure, shall not be covered by the warranty.*

**NOTICE**



- Please use the charger provided by the manufacturer to charge the battery.
- The charging process must be complete, and frequent intermittent charging can damage the battery.
- The battery is only applicable for the mated equipment supplied together at delivery, so do not use the battery for other purposes.
- Do not reverse the positive and negative poles of the battery for use.
- Do not short-circuit the positive and negative poles of the battery system.

# 3 RESPONSIBILITIES OF RELEVANT PARTIES

## 3.1 OWNER'S (OR LESSOR'S) RESPONSIBILITIES

- The owner (or lessor) is obliged to help the user understand all the instructions in the manual.
- The owner (or lessor) is obliged to provide the latest manuals or replace missing or damaged labels. For the latest manuals of the machine, please contact Sinoboom or its authorized agents.
- The owner (or lessor) is obliged to comply with local regulatory requirements related to the use of the machine.

## 3.2 EMPLOYER'S RESPONSIBILITIES

- The employer is obliged to issue an operator license for the user.
- The employer is obliged to ensure that the user is healthy and has good judgment, sense of cooperation and psychological quality.
- The employer is obliged to ensure that signalmen have good visual and auditory judgment, master standard command signals and send clear and accurate signals, and have sufficient experience to identify hazards and inform operators to avoid hazards in time.
- The employer is obliged to clarify the corresponding safety responsibilities to each operator and require them to report unsafe factors to the supervisor timely.

## 3.3 TRAINER'S RESPONSIBILITIES

- The trainer must be accredited by Sinoboom as who has received comprehensive knowledge training on the machine, and has the required competencies related to machine repair and maintenance.
- The trainer must conduct training in an open area free of hazards until the trainees acquire the ability to safely control and operate the machine.

## 3.4 USER'S RESPONSIBILITIES

- The user must be properly trained on MEWP and authorized.
- The user must carefully read and fully understand this manual and the decals on the machine.
- The user must report to the owner (lessor) all anomalies that may cause the machine to work abnormally or have potential dangers, and if possible, correct the abnormal situation timely while ensuring safety.
- The user must be fully aware of the content and procedures of the operation item.
- The user must be familiar with and comply with signal instructions and operation requirements in emergency situations.
- The user must observe the presence of dangerous situations and report the hazard reminder to other operators and watchouts in time. Such as high-voltage lines, unrelated personnel, and unfavorable ground conditions.
- The user must stop using the machine in case of unfavorable operation or dangerous conditions.

**This Page Intentionally Left Blank**

# 4 TECHNICAL PARAMETERS

## 4.1 MACHINE SPECIFICATIONS

Table 4-1 Specifications

ITEM	Metric	Imperial
Product Category		
Power type	Battery	
Outrigger type	Fixed outrigger	
DIMENSION		
Max. platform height	9.62m	32ft 7in
Max. working height	11.62m	39ft 4in
Max. horizontal reach	6.3m	20ft 8in
Max. horizontal working envelope	6.9m	22ft 8in
Max. up and over height	4.63m	15ft 2in
Overall length (stowed)	5.72m	18ft 9in
Overall length (transport)	4.11m	13ft 6in
Overall width (stowed)	1.19m	3ft 11in
Overall width (transport)	1.19m	3ft 11in
Overall height (stowed)	1.99m	6ft 6in
Overall height (transport)	2.5m	8ft 2in
Wheelbase	1.65m	5ft 5in
Ground clearance (with pothole protection device retracted)	0.09m	3.5in
Ground clearance (with pothole protection device extended)	0.03m	1.1in
Platform dimension (L×W×H)	1.15×0.76×1.1m	45.3×30×43.3in
PERFORMANCE		
Maximum load capacity of platform	230kg (unrestricted)	507lb (unrestricted)
Max. number of occupants	2 persons (unrestricted)	
Drive speed (stowed)	5km/h	3.1mph
Drive speed (raised)	0.8km/h	0.5mph
Gradeability	35%/19.3°	
Turntable rotation (angle/continuity)	355°/non-continuous	
Platform rotation angle	180°	
Max allowable tilt angle	3°	

**Table 4-1 Specifications (Continued)**

ITEM	Metric	Imperial
Turning radius (inside/outside)	1.7m/3.25m	5ft 7in/10ft 8in
Turntable tail-swing	0m	0m
Tire (spec/type)	0.56×0.18×0.45m (solid, non-marking)	22×7×17.75in (solid, non-marking)
Max. operating noise level	72dB	
IP rating	IP65	
Max. total vibration value of the platform	2.5m/s <sup>2</sup>	
Max. root-mean-square value of the weighted acceleration of the entire machine	0.5m/s <sup>2</sup>	
<b>POWER</b>		
Travel motor (rated power/rpm)	3kW, 1572rpm	
Drive×steer	2WD×2WS	
Hydraulic tank volume	20L	4.4gal (UK)/5.3gal (US)
Oil capacity of hydraulic tank	17L	4.4gal (UK)/3.7gal (US)
Hydraulic system pressure	21MPa	3045psi
Battery (number×voltage, capacity)	8×6V, 330Ah (lead-acid battery)	
Control voltage	12VDC	
<b>WEIGHT</b>		
Gross weight (unladen)	6760kg	14903lb
<b>GROUND BEARING DATA</b>		
Max. tire load	3580kg	7893lb
Pressure against ground	725kPa	105psi
<b>ENVIRONMENT</b>		
Max. allowable side force	400N	90lbf
Max. allowable wind speed	12.5m/s	28mph
Max. allowable altitude	1000m	3280ft
Allowable ambient temperature (lead-acid battery)	-10°C ~ 40°C	14°F ~ 104°F
Allowable ambient temperature (lithium battery)	-20°C ~ 40°C	-4°F ~ 104°F
Max. allowable relative humidity	90%	

Table 4-1 Specifications (Continued)

ITEM	Metric	Imperial
Storage environment	Stored at -20°C to 50°C (-4°F to 122°F) in a well-ventilated environment with 90% relative humidity (20°C [68°F]), and away from rain, sun, corrosive gas, inflammables and explosives.	

**Note:**

- a) The platform height plus the operator height (taken as 2m [6ft 7in]) is the working height.
- b) The maximum horizontal reach plus the arm length of the operator (taken as 0.6m [1ft 11in]) is the maximum horizontal working envelope.
- c) The ground bearing data is approximate, without considering different options, thus it is applicable only in adequately safe conditions.
- d) In different areas, hydraulic oil, engine oil, coolant, fuel and lubricant should be added in accordance with the environmental temperature.
- e) In cold weather, auxiliary devices are needed to start the machine.
- f) Rated platform load capacity refers to the maximum allowable load on the platform, including the weight of persons, materials, tools, accessories and other objects.
- g) It's recommended not to use the lead-acid battery under the ambient temperature below 0°C, otherwise the battery capacity will decay rapidly and the battery life will be affected.

4.2 MOVEMENT SPEED

Table 4-2

ITEM	Test results
Raise the main boom	24 ~ 32s
Lower the main boom	22 ~ 30s
Raise the articulated boom	22 ~ 30s
Lower the articulated boom	18 ~ 23s
Rotate the turntable (355°)-with boom fully retracted	60 ~ 70s
Rotate the turntable (355°)-with boom extended	90 ~ 100s
Extend the main boom	18 ~ 22s
Retract the main boom	13 ~ 17s
Rotate the platform (180°)	8 ~ 13s
Level the platform upward	16 ~ 21s
Level the platform downward	15 ~ 20s
Raise the jib boom	24 ~ 30s
Lower the jib boom	20 ~ 24s
Rotate the jib boom	15 ~ 19s
Max drive speed (30m [98.4ft]) -stowed	19 ~ 23s
Max drive speed (30m [98.4ft]) -operating	130 ~ 140s

Table 4-2 (Continued)

ITEM	Test results
Brake distance at maximum speed in high gear	≤2m (6.6ft)

- a) The movement speed depends on the start point and end point of the movement, rather than on the controls or switches.
- b) The test results of drive speed vary with tires of different specifications.
- c) All the speed tests should be conducted from the platform controller. The test results will differ if tested from the turntable controller.
- d) All the tests should be conducted with the hydraulic oil temperature at 50 ~ 60°C (122 ~ 140°F). If the hydraulic oil temperature is too low, the test results will be affected.

**Test requirements:**

**Raise/lower the main boom :** With the articulated boom fully lowered, and the telescopic boom fully retracted, raise the main boom from the lowest to the highest and lower the main boom from the highest to the lowest for two times.

**Raise/lower the articulated boom :** Raise the articulated boom from the lowest to the highest and lower the articulated boom from the highest to the lowest for two times.

**Rotate the turntable :** With the boom stowed, rotate the turntable through two full cycles.

**Extend/retract the main boom :** With the main boom horizontally positioned, extend the main boom from fully retracted to fully extended position, and retract the main boom from fully extended to fully retracted position for two times.

**Rotate the platform** : With the platform horizontal, rotate the platform from the leftmost to the rightmost, and rotate the platform from the rightmost to the leftmost for two times.

**Level the platform** : Level the platform upward from the lowest to the highest, and level the platform downward from the highest to the lowest for two times.

**Raise/lower the jib boom** : With the platform horizontal, raise the jib boom from the lowest to the highest, and lower the jib boom from the highest to the lowest for two times.

**Rotate the jib boom** : With the platform horizontal, rotate the jib boom from the leftmost to the rightmost, and rotate the jib boom from the rightmost to the leftmost for two times.

**Drive-stowed position** : With the machine in stowed position on level surface, switch to the high gear, and push the drive joystick to maximum travel distance to drive the machine forward and reverse for 30m/98.4ft respectively for two times.

**Drive-operating position** : With the machine in operating position on level surface, push the drive joystick to maximum travel distance to drive the machine forward and reverse for 30m/98.4ft respectively for two times.

**Brake distance**: As indicated by the “drive-stowed position” test, once the machine reaches the maximum drive speed, immediately release the joystick (starting timing) until the machine stops. Test twice.

# 5 PRE-OPERATION INSPECTION

Before each start of work, restart of work and change of user, and after each repair, the pre-operation inspection must be performed, and each inspection item must be carefully performed according to the requirements of this section.

5.1 MACHINE COMPONENTS

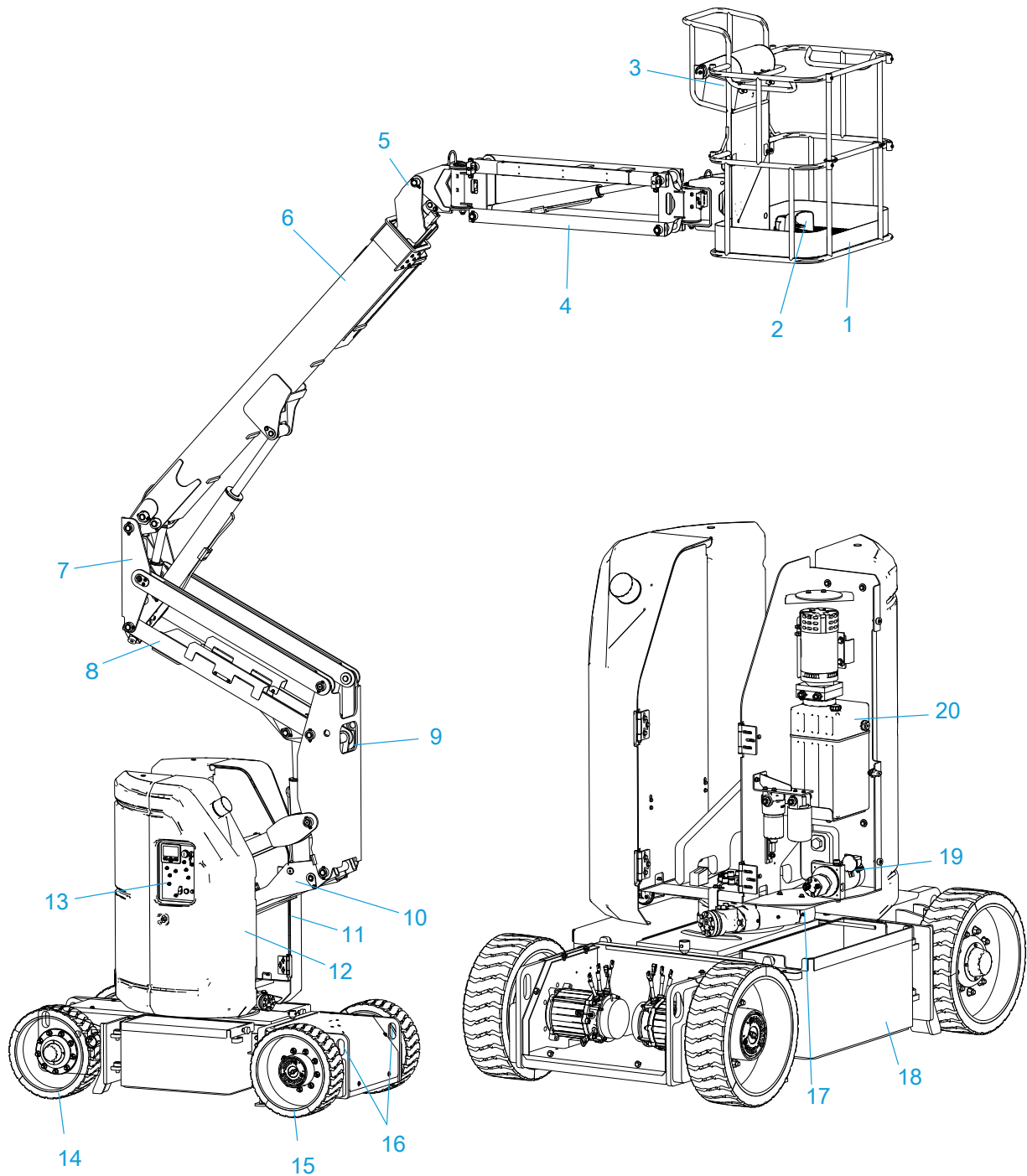

Fig 1 Machine components

Table 5-1

1. Platform	2. Foot switch	3. Platform controller
4. Jib boom	5. Telescopic boom	6. Main boom
7. Upper connector	8. Upper articulated boom	9. Lower connector

**Table 5-1 (Continued)**

<b>10.</b> Lower articulated boom	<b>11.</b> Right turntable cover	<b>12.</b> Left turntable cover
<b>13.</b> Turntable controller	<b>14.</b> Front wheel (steering wheel)	<b>15.</b> Rear wheel (non-steering wheel)
<b>16.</b> Lanyard anchorage point	<b>17.</b> Slewing mechanism	<b>18.</b> Battery box
<b>19.</b> Emergency power unit	<b>20.</b> Power unit	

## 5.2 MACHINE POSITIONS

The machine can be set in stowed, transport, operating and non-operating positions. Each position is described in detail below:

- **Stowed position:** The articulated boom is fully lowered, and the main boom is fully retracted and lowered.
- **Transport position:** The articulated boom is fully lowered, and the main boom is fully retracted and lowered. The jib and platform are positioned as appropriate for transportation with trailer.
- **Operating position:** The down limit switch of the main boom or the articulated boom is not engaged, or the retraction limit switch of the main boom is not engaged.
- **Non-operating position:** The down limit switch of the main boom and the articulated boom is engaged, and the retraction limit switch of the main boom is engaged.

## 5.3 PRE-START INSPECTION

**⚠ WARNING**

**If the machine is found to be damaged, not working properly, or has any unauthorized changes that differ from the conditions before delivery, the machine should be stopped and marked immediately. Report the fault to the relevant maintenance personnel and do not operate the machine until safe operation can be guaranteed.**

The pre-start inspection shall include the followings:

1. **Cleanliness**—Check all surfaces of the machine for leaks (hydraulic oil, fuel, engine oil or battery electrolyte, etc.) or foreign objects.
2. **Structure**—Check whether the structure is depressed, damaged, cracked, seriously rusted, or severely corroded.
3. **Operation Manual and Maintenance Manual**—Ensure that the Operation Manual and Maintenance

Manual are intact, easy to read, and stored in the manuals storage box on the platform.

4. **Decals and nameplate**—Ensure that all labels and nameplate are not missing and damaged, and are accurately located and visible.

**⚠ WARNING**

**Do not operate the machine if any label or nameplate is missing or worn.**

5. **Maintenance**—Ensure that the maintenance work has been completed in accordance with the maintenance inspection requirements specified in the Maintenance Manual.
6. **Battery**—Charge the battery as required. The electrolyte level, if adjustable, must be kept at an appropriate height.
7. **Fuel level (if equipped with an engine)**—Add appropriate fuel as needed.
8. **Engine oil level (if equipped with an engine)**—Make sure the oil level is between the “FULL” and “ADD” level of the oil dipstick and that the filler cap is tightened.
9. **Coolant level (if equipped with a water-cooled engine)**—Add coolant as needed.
10. **Hydraulic oil**—Check the hydraulic oil level. Add appropriate hydraulic oil as needed.
11. **Options/accessories**—If the machine is equipped with any options/accessories, consult this manual and the supplemental manuals for options/accessories for inspection, operation and maintenance instructions.
12. **Machine components**—Check the following components to ensure that they are correctly installed and firmly fixed without loose, missing or altered parts and visible damage, leakage or excessive wear, etc., and that all components are in their original positions and normal working states, in addition to checking other stated items.
  - 1) **Platform assembly and gate**—Ensure that the foot switch is working properly and has not been altered, closed or blocked; Ensure that the lanyard lashing points are safe and reliable, and each lashing point is only for one person; Make

sure the latches and hinges are in normal working states, that the platform gate can open and close properly without bends or damage, and that the surrounding area is free of obstacles. The gate should remain closed at all times, except for entering/exiting platform and loading/unloading materials;

- 2) Turntable controller and platform controller—Ensure that all control switches are off, that joysticks are in the neutral position and can return to the neutral position after activated and released, and that all control markings are visible;
- 3) Platform rotating device;
- 4) Boom assembly;
- 5) Jib boom assembly;
- 6) Drag chain system;
- 7) Turntable and turntable cover;
- 8) Engine, fuel tank and related components (if equipped with an engine);
- 9) Power motor and related components (if equipped with a power motor);
- 10) Turntable rotation device;
- 11) Slewing drive devices (motor, reducer, etc.);
- 12) Turntable bearings—Ensure that they are accurately lubricated and that no bolts between the bearing and the machine are loose or missing;
- 13) Turntable rotation pin (if equipped)—Ensure it works properly, and ensure that the turntable rotation pin can lock/unlock the turntable;
- 14) Tire assembly—Ensure that the tire assembly is firmly secured and wheel nuts are not loose or missing; check for worn tread, cuts, breakage or other abnormalities;
- 15) Travel drive devices (motor, reducer, hub, etc.);
- 16) Steering connecting rod and steering connecting disc;
- 17) Pothole protection device—extend and retract normally;
- 18) Hydraulic cylinder, valve block, pump, oil tank, hoses, pipe joints and other hydraulic parts;
- 19) Electrical parts such as limit switches and cable harnesses.

## NOTICE

*Never forget to inspect the platform floor, which may reveal conditions that could result in personal injury or machine damage.*

## 5.4 FUNCTIONAL TEST

Before performing the functional test:

- Choose a solid, flat and horizontal test area.
- Make sure there are no obstructions in the test area.

### WARNING

**For telescopic boom with three or more segments, when checking the extending/retracting function of the boom, ensure that all boom segments extend/retract together at the same speed. In case of any abnormality, there may be a delay in movement and loose wire ropes. Please immediately lower the platform to the stowed position, turn off the machine, and have the wire rope inspected and repaired by a qualified service technician.**

### WARNING

**If any switch/handle returns to the neutral position and the corresponding movement does not stop, remove the foot from the foot switch or push in the emergency stop button to stop the machine.**

### NOTICE

- *When the emergency power is in use, do not perform two or more functions at the same time, because certain function operation may have no response due to small flow in the emergency motor or pump.*
- *The emergency power switch can only be used for a short time (to fully lower and retract the platform from the maximum angle and maximum length) when the main power source is not working, because long-time operation may bring damage to the motor.*

Follow these steps to perform the functional test:

1. With no load applied on the platform, turn the ground/platform control selector switch on the ground controller to the ground control position, pull out the emergency stop button on the ground controller, and perform the following tests from the ground controller:
  - 1) Make sure that the relevant indicator lights on the display are on and that no error or alarm message is displayed during the entire functional test.
  - 2) Make sure that when the emergency stop button on the ground controller is pressed, the

controller will be powered off, the machine cannot be started and all functions cannot work.

- 3) Make sure that the horn sounds properly when the horn button is pressed.
  - 4) Activate the engine start switch, and the engine should start smoothly without abnormal noise (This test is required if the machine is equipped with an engine).
  - 5) Activate any action switch without activating the enable switch, and the corresponding action cannot operate.
  - 6) Activate the enable switch and any action switch at the same time, and the corresponding action shall operate normally.
  - 7) With the main power source turned off, activate the emergency power switch and any boom action switch at the same time, and the corresponding action shall operate normally. After that, deactivate the emergency power and restart the engine.
2. Turn the ground/platform control selector switch on the ground controller to the platform control position, pull out the emergency stop button on the ground controller and platform controller, and perform the following tests from the platform controller:
- 1) Make sure that when the emergency stop button on the platform controller is pressed, the platform controller shall be powered off and all functions on the platform controller cannot work.
  - 2) Make sure that the horn sounds properly when the horn button is pressed.
  - 3) Activate the engine start switch, and the engine should start smoothly without abnormal noise (This test is required if the machine is equipped with an engine).
  - 4) Activate any action switch/handle without depressing the foot switch, and the corresponding action cannot operate.
  - 5) Depressing the foot switch and activate any action switch/handle at the same time, and the corresponding action shall operate normally. Move the switch/handle to the neutral position after one action is performed, and the corresponding action should be stopped reliably and safely.
 

**Note:** When the travel function handle is released, the brake must be able to hold the machine on any slope within the maximum climbing angle reliably without sliding.
  - 6) Move any action switch/handle 7s after the foot switch is depressed, and the corresponding action cannot operate and the buzzer will sound.
  - 7) When the boom rotates beyond the rear wheels, the rear position indicator light should flash and the travel function should be turned off. After pressing the rear position travel drive switch, the

rear position indicator light shall be solid on, and the travel function shall be reactivated.

### **WARNING**

**At this time, the direction of travel and steering of the machine shall be opposite to the indicated direction. Please operate the machine with caution!**

- 8) With the machine in non-operating position, push upward the high/low drive speed selector switch, and the machine will start to run at high speed; push the travel control handle to full drive position, and the machine will travel at the maximum travel speed.
- 9) With the machine in operating position, push upward the high/low drive speed selector switch, and the machine will start to run at low speed; push the travel control handle to full drive position, and the machine will travel at low speed.
- 10) When the machine travels to a slope with the grade greater than or equal to the maximum allowable tilt angle of the machine and smaller than or equal to the maximum allowable climbing angle of the machine, the chassis tilt indicator icon will be on, and the tilt alarm will be triggered.
- 11) Without activating the main power source, depress the foot switch, and activate the emergency power button and any boom action switch at the same time, and the corresponding action shall operate normally. After that, deactivate the emergency power.

**This Page Intentionally Left Blank**

# 6 CONTROLLERS AND INDICATORS

This chapter provides the brief introduction of switches, handles and displays on the ground controller and platform controller. Refer to the **Operation Instructions** section for the detailed description.

## 6.1 TURNTABLE CONTROLLER

### NOTICE

The manufacturer does not have direct control over the application and operation of the machine. Users and operators are responsible for complying with the applicable safety specifications.

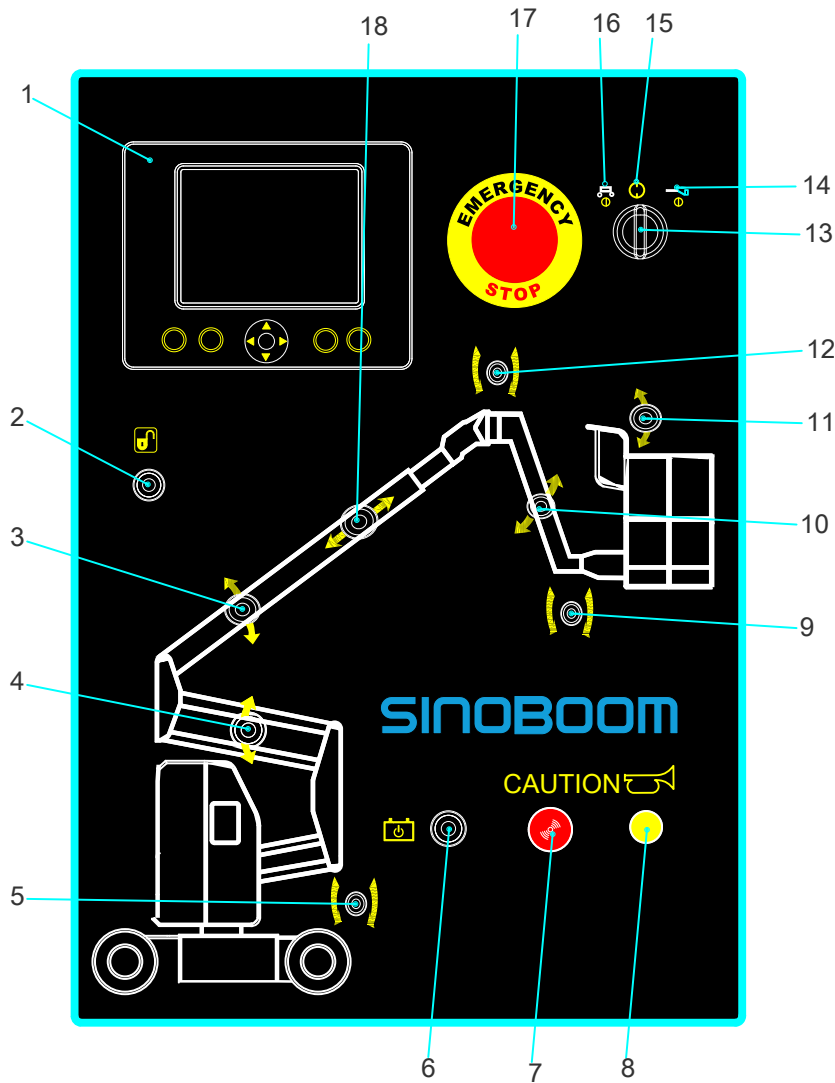
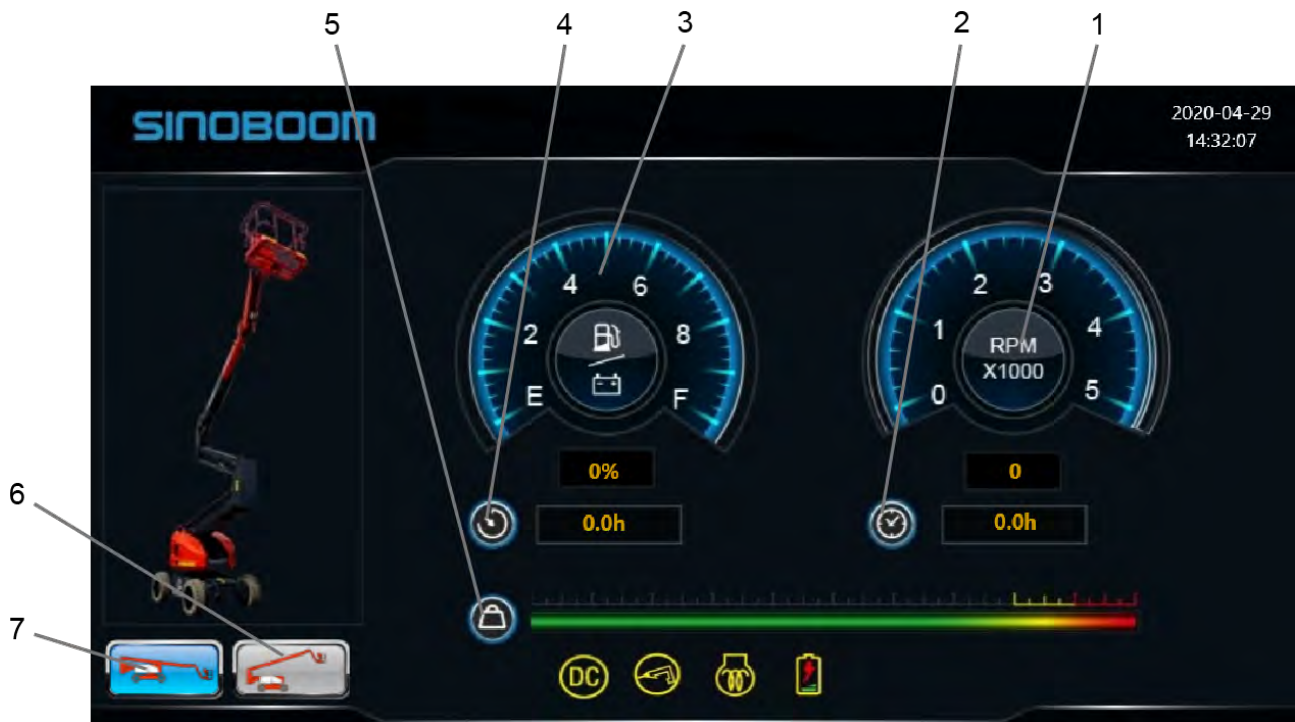

Fig 1 Turntable controller

**Table 6-1**

No.	Indication	Description
1	Turntable display	Provide machine working states, fuel/battery level, fault codes & query, and other information.
2	Enable switch	Move and hold the switch, and all functions will be enabled to operate.
3	Main boom luffing switch	Control main boom luffing.
4	Articulated boom luffing switch	Control articulated boom luffing.
5	Turntable rotation switch	Control turntable rotation.
6	Emergency power switch	Provide emergency power in case of main power source failure.
7	Buzzer	Under different circumstances, the buzzer issues sound and light alarms with different frequencies.
8	Horn	Press the button, and the horn will sound.
9	Platform rotation switch (if equipped)	Control platform rotation.
10	Jib boom luffing switch	Control jib boom luffing.
11	Platform leveling switch	Adjust platform levelness while traveling up/down the slope.
12	Key switch (ground/platform control selector switch)	Turn the switch to OFF position (neutral), the machine will be turned off; Turn the switch to the left to Ground control position, and all functions will be operative only at the turntable controller, while the platform controller will not work; Turn the switch to the right to Platform control position, and all functions will be operative only at the platform controller, while the turntable controller will not work
13	Jib boom rotation switch	Control jib boom rotation.
14	Platform control position	/
15	OFF position (neutral)	/
16	Ground control position	/
17	Emergency stop button	Pull out the button to ON position, and the machine will start normally; Push the button to OFF position, the controller will be powered off, the machine cannot start and all functions will be inoperative.
18	Main boom telescope switch	Control main boom extending/retracting.

**6.2 TURNTABLE DISPLAY**



**Fig 2 Ground controller display**

**Table 6-2**

No.	Indication	Description
1	Tachometer	To display the current engine speed.
2	Accumulated working hours	To display the machine's accumulated working hours.
3	Fuel/battery level indicator	To display the remaining fuel oil/battery level in percentage.
4	Current working hours	To display the machine's current working hours.
5	Platform load	To display the load weight on the platform.
6	Operating position	This icon lights up to indicate: that the machine is in operating position.
7	Non-operating position	This icon lights up to indicate: that the machine is in non-operating position.

6.3 PLATFORM CONTROLLER

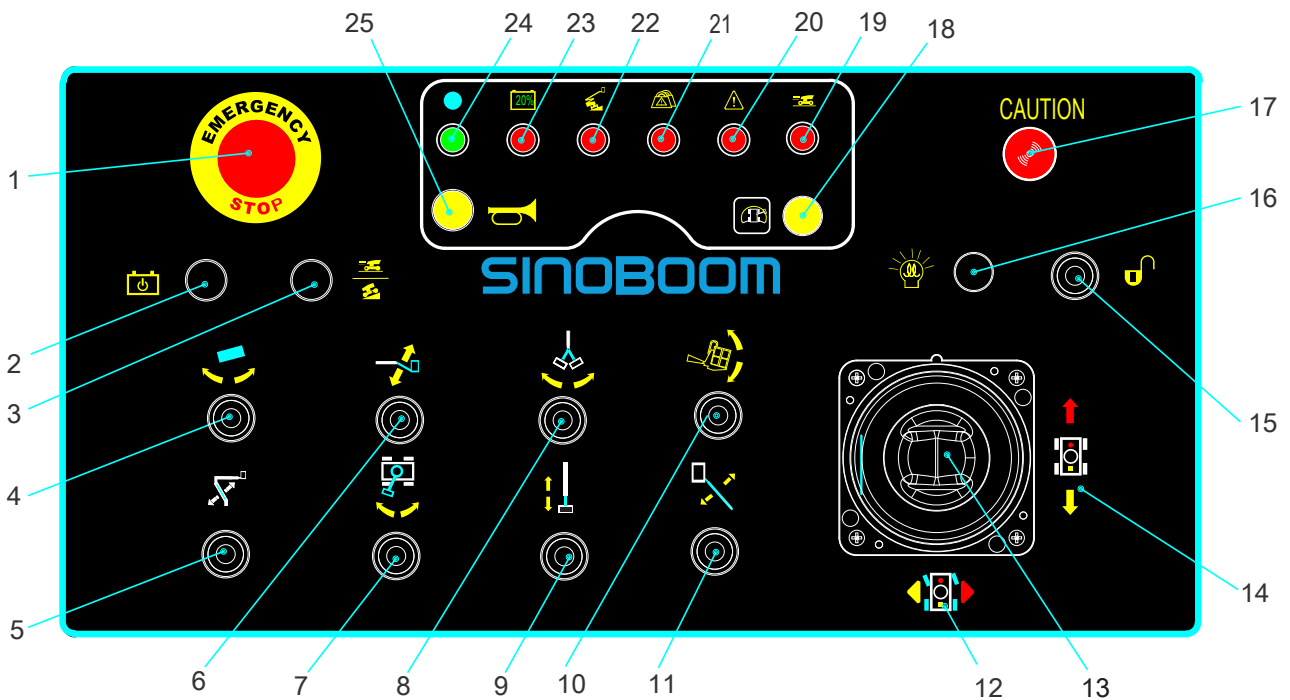

Fig 3 Platform Controller

Table 6-3

No.	Indication	Description
1	Emergency stop button	Pull out the button to ON position, and the machine will start normally; push the button to OFF position, the controller will be powered off, the machine cannot start and all functions will be inoperative.
2	Emergency power switch	Provide emergency power in case of main power source failure.
3	High/low travel speed selector switch	Switch between high and low travel speed.
4	Platform rotation switch	Control platform rotation.
5	Articulated boom luffing switch	Control articulated boom luffing.
6	Jib boom luffing switch (if equipped)	Control jib boom luffing.
7	Turntable rotation switch	Control turntable rotation.
8	Jib boom rotation switch (if equipped)	Control jib boom rotation.
9	Main boom telescope switch	Control main boom extending/retracting.
10	Platform leveling switch	Adjust platform levelness while traveling up/down the slope.
11	Main boom luffing switch	Control main boom luffing.
12	Steering control orientation	Provide indication for wheel steering control orientation.
13	Travel/steer joystick	Push the joystick forward/backward to drive the machine forward/backward;

**Table 6-3 (Continued)**

No.	Indication	Description
		Press the left/right button on the joystick to steer the machine to left/right.
14	Travel control orientation	Provide indication for travel control orientation.
15	Release switch (if equipped)	After the Secondary Guarding is triggered, move this switch to continue the override operation.
16	Working lamp switch (if equipped)	Turn on/off the working lamp.
17	Buzzer	Under different circumstances, the buzzer issues sound and light alarms with different frequencies.
18	Reverse position travel switch (with reverse position indicator)	The reverse position indicator flashes to indicate: the boom moving beyond the rear wheels; Press the switch when the reverse position indicator is flashing, and the travel function will resume. Please note that, in such case, the traveling and steering direction of the machine is opposite to the indicated direction.
19	High travel speed indicator	This icon lights up to indicate: that the machine starts to travel at high speed.
20	System fault indicator	This icon lights up to indicate: low fuel level, low engine oil pressure, high engine water temperature, CAN bus error, or other faults.
21	Overload alarm indicator	This icon lights up to indicate: that the load on the platform exceeds its rated load.
22	Chassis tilt indicator	This icon lights up to indicate: that the chassis tilt angle exceeds the maximum allowable tilt angle.
23	Low battery level indicator	This icon lights up to indicate: low battery level.
24	Power indicator	This indicator lights up to indicate that the platform controller has normal power supply.
25	Horn	Press the button, and the horn will sound.

**This Page Intentionally Left Blank**

# 7 OPERATION INSTRUCTIONS

## 7.1 GENERAL

This mobile elevating work platform is used to transport tools to work locations and for performing tasks on the work platform. This machine has two controllers: ground controller and platform controller.

### WARNING

- Unless in case of emergency, it is forbidden to perform operations from the ground if any person is still on the platform.
- If any switch/handle returns to the neutral position but the corresponding movement does not stop, remove the foot from the foot switch or push in the emergency stop button to stop the machine.

## 7.2 STABILITY

The machine stability is based on two conditions: forward stability and backward stability. See the following figures and description for the positions of the least forward stability and the least backward stability.

### WARNING

Do not overload the platform or operate the machine on tilted surface exceeding the maximum allowable tilt angle to prevent forward or backward tipping.

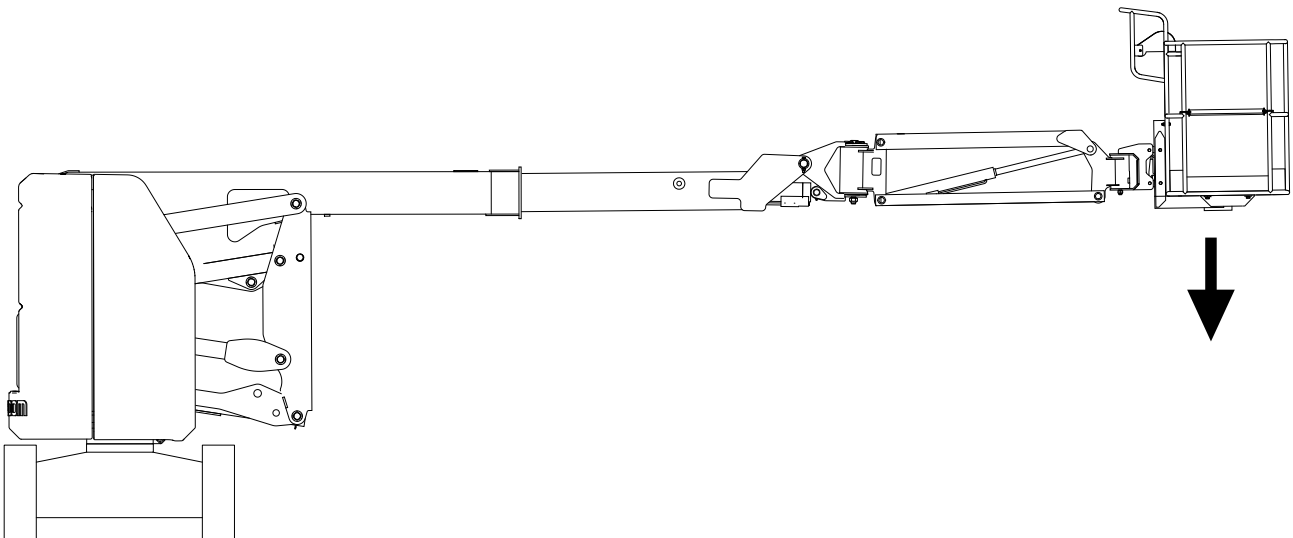
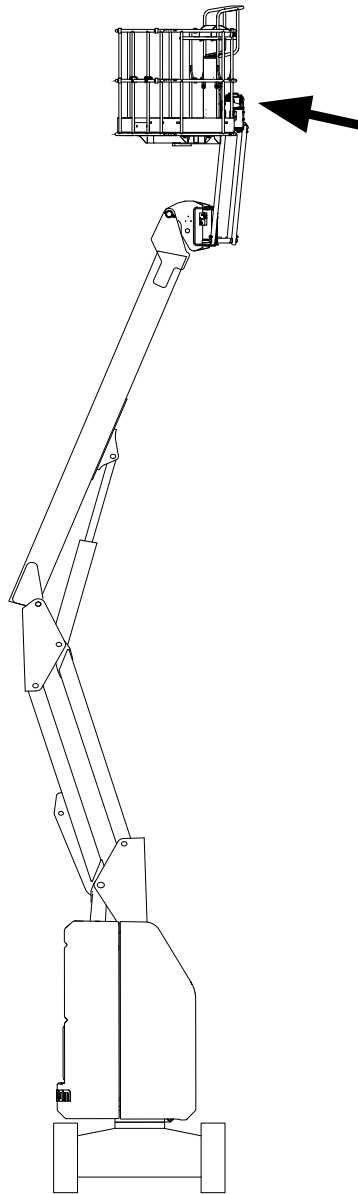

Fig 1 Position of least forward stability

1. Articulated boom fully retracted;
2. Main boom horizontal and fully extended;
3. Jib raised to horizontal;
4. Turntable rotated 90°;
5. The machine will tip over in the direction as indicated by the arrow if overloaded or operating on a tilted surface exceeding the maximum allowable tilt angle.



**Fig 2 Position of least backward stability**

1. Articulated boom fully elevated;
2. Main boom fully retracted and elevated;
3. Jib boom fully elevated and rotated to the maximum angle on one side;
4. Platform rotated 90° to the same side of jib boom;
5. Turntable rotated 90°;
6. The machine will tip over in the direction as indicated by the arrow if overloaded or operating on a tilted surface exceeding the maximum allowable tilt angle.

## 7.3 GRADEABILITY

Gradeability refers to the maximum allowable slope angle the machine can climb when it is on solid ground and has sufficient traction and the platform is stowed and carrying only one person. As the load on the platform increases, the maximum allowable slope angle will be decreased.

**WARNING**

**Do not drive the machine on the slope exceeding the machine's maximum allowable climbing angle.**

The gradeability (maximum climbing angle) include up-slope/downslope and side slope climbing ability. The up-slope/downslope climbing ability of this machine:



Downslope: 35%/19.3°

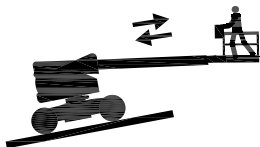

Upslope: 20%/11°

The side slope climbing ability of this machine:

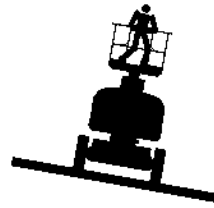

Side slope: 25%/14°

## 7.4 DIAGRAM OF WORKING ENVELOPE

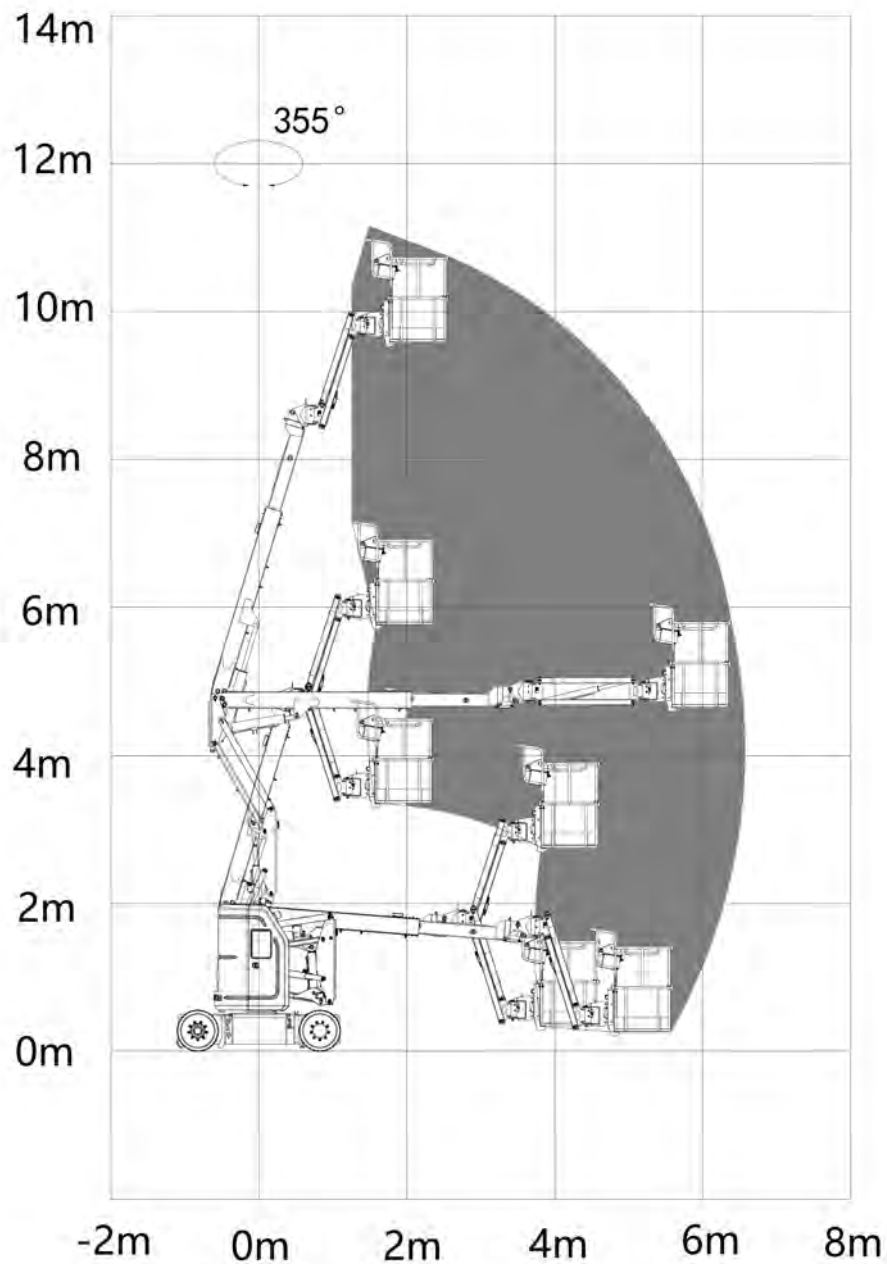

Fig 3 Diagram of Working Envelope

## 7.5 CHARGING THE BATTERY

The batteries used include 3 types: lead acid battery, lead acid maintenance-free battery and lithium battery, and the latter two batteries do not need maintenance.

The battery level must be checked before each operation.

When the battery level is less than 20%, the low battery indicator icon on the turntable controller lights up, the red battery level indicator light illuminates, the buzzer sounds intermittently, and the travel speed of the machine at high speed will be reduced. Stop the machine immediately and fully charge the battery.

**NOTICE**

- *The machine is delivered with a battery level less than 80%, so it is recommended that the battery be fully charged after receiving the shipment.*
- *The charging current cannot exceed the maximum allowable charging current indicated on the battery.*
- *The charging voltage must not exceed the maximum allowable limit voltage indicated on the battery.*
- *The charging temperature range is -10°C-45°C. If a charge heating system is available, the charging temperature range would be -20°C-45°C.*
- *Battery over-discharge (continued use of battery with level of less than 15%) or battery under-voltage caused by long-term non-charging (battery with level of less than 15% not charged for more than three days), resulting in battery capacity attenuation and failure, shall not be covered by the warranty.*
- *It's recommended not to use the lead-acid battery under the ambient temperature below 0°C; otherwise the battery capacity will decay rapidly, and the battery life will be affected.*

**Charge lead-acid (maintenance-required) batteries**

1. Check the battery level.
  - Check the battery level via the turntable controller display. When the battery level is  $\leq 20\%$ , the low battery alarm will be triggered and the battery needs to be charged immediately. For the purpose of not affecting the normal operation of the machine, it is recommended to charge the battery when the battery level is lower than 30%.
  - Alternatively, open the cover on the battery and measure the density of the electrolyte. If the density of the electrolyte is less than 1.13kg/l, it means that the battery has been over-discharged (the depth of discharge exceeds 80%) and must be charged immediately. This should be avoided, as frequent over-discharge will reduce the service life of the battery.

**NOTICE**

*Measure the temperature of the electrolyte. If it is higher than 45°C, wait for the battery to cool before proceeding to the following steps.*

2. Completely power off the machine.
3. Connect the plug between the battery and the charger cable. If the machine is equipped with an automatic water refilling system, ensure that the refilling pipe is connected.
4. Connect the battery charger to a grounded AC circuit. The indicator light will be on after the battery is fully charged.
5. After charging is complete, disconnect the cable plug from the battery to the charger.

**Charge maintenance-free batteries**

1. Check the battery level on the display of the turntable controller. When the battery level is  $\leq 20\%$ , the low battery alarm will be triggered and the battery needs to be charged immediately. For the purpose of not affecting the normal operation of the machine, it is recommended to charge the battery when the battery level is lower than 30%.
2. Completely power off the machine.
3. Connect the charger to a grounded AC circuit. The indicator light will be on after the battery is fully charged.
4. After charging is complete, disconnect the cable plug from the battery to the charger.

**Harness Connection**

**Charging with 16A cable (slow charging):**

Select 16A adapter cable to connect with the machine charging port and the 220VAC/110VAC mains supply on the customer side.

- The input voltage of power source and the rated power of protective devices such as breaker in the customer-side controller shall be as follows:

Input voltage	Rated power
110VAC	$\geq 1.5\text{kW}$
220VAC	$\geq 3\text{kW}$

- Please refer to the following table to reasonably select the diameter and length of the charging cable;

Cable diameter	Cable length
2.5mm <sup>2</sup>	$\leq 10\text{m}$
4mm <sup>2</sup>	$10\text{m} \leq L \leq 100\text{m}$

- The socket for the charger plug needs to be wired in strict accordance with the model requirements in the figure below, and the rated parameters of the socket must be 220VAC-16A-3kW or 110VAC-16A-1.5kW.

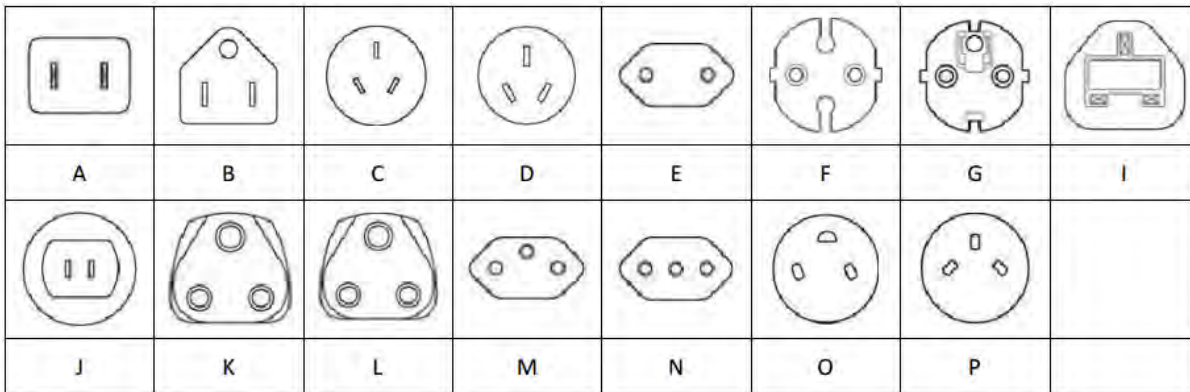

### Charging with 32A cable (fast charging):

1. Select 32A adapter cable to connect with the machine charging port and the 220VAC (380VAC)/110VAC (210VAC) mains supply on the customer side. Only industrial plugs can be used.
2. Find the fast charging mode toggle button on the side of the battery box on the left side of the machine, press and hold the button 3s, and the fast charging mode will be activated.
3. The slow charging mode will resume automatically after power-off.

Note: For machines with the reach below 26m, only lithium batteries are equipped with the fast charging function.

- The input voltage of power source and the rated power of protective devices such as breaker in the customer-side controller shall be as follows:

Input voltage	Rated power
110VAC (210VAC)	≥3kW
220VAC (380VAC)	≥6kW

- Please refer to the following table to reasonably select the diameter and length of the charging cable;

Voltage-power	Cable diameter	Cable length
220VAC-3kW 110VAC-1.5kW	2.5mm <sup>2</sup>	≤10m
380VAC-6kW 210VAC-3kW	4mm <sup>2</sup>	10m≤L≤100m

### Charging Display

1. After the charger is connected to mains supply, the LED light will flash and then the default charging curve code will be displayed.
2. After the curve code is displayed, the charger will enter charging mode.
3. In charging mode, the charging indicator lights up in different ways based on the charging progress.
  - When the battery level is less than 50%, the 50% indicator flashes at low frequency;
  - When the battery level is greater than or equal to 50% but less than 75%, the 75% indicator flashes at high frequency;
  - When the battery level is greater than or equal to 75% but less than 100%, the 100% indicator is solid on;
  - When the battery fails, the battery fault indicator

is solid on.

## 7.6 TURNTABLE ROTATION

**WARNING**

**Before performing turntable rotation, make sure that the boom is sufficiently distant from surrounding walls, obstacles, etc.**

### Perform operation from the ground:

1. Rotate the turntable clockwise: Move and hold the enable switch, and push the turntable rotation switch downwards, the turntable will rotate clockwise.

2. Rotate the turntable counterclockwise: Move and hold the enable switch, and push the turntable rotation switch upwards, the turntable will rotate counterclockwise.

### Perform operation from the platform:

1. Rotate the turntable clockwise: Depress the foot switch, push the turntable rotation switch to the left, and the turntable will rotate clockwise.
2. Rotate the turntable counterclockwise: Depress the foot switch, push the turntable rotation switch to the right, and the turntable will rotate counterclockwise.

## 7.7 TRAVELING

### WARNING

- The machine cannot travel with the boom positioned higher than the horizontal unless it is on a solid and flat surface without exceeding the maximum allowable climbing angle.
- It is forbidden to drive the machine on slopes, steps or arched surfaces that exceed the maximum allowable climbing angle of the machine.
- Before traveling, confirm the traveling control direction, and make sure the boom is above the rear-wheel drive axle. If the boom is above the front-wheel axle, the traveling and steering control directions will be opposite to the indicated directions.
- Extreme care must be taken when driving the machine in reverse or with the platform raised.
- When driving the machine in potentially dangerous situations, such as driving on slopes or in reverse, limit the travel distance of the handle to avoid dangerous situations due to fast driving.

**Note:** The travel speed is in direct proportion to the travel distance of the handle. The shorter the travel distance, the slower the speed.

### Driving Forward and Reverse

1. Driving forward: Depress the foot switch and push the travel/steer control handle forward, and the machine will travel forward.
2. Driving backward: Depress the foot switch and push the travel/steer control handle backward, and the machine will travel backward.
3. When the boom is above the rear-wheel drive axle, the control direction of traveling and steering of the platform controller will be indicated by the red and

yellow directional arrows on the chassis.

4. When the boom moves beyond the rear wheel, the rear position indicator will flash, and the travel function will be turned off. To restore the travel function: Press the rear position travel switch, the rear position indicator will turn on, and the travel function will resume. (At this time, the control direction of traveling and steering of the machine will be opposite to the red and yellow directional arrows on the chassis)

### Steering While Traveling

1. Steer left: Depress the foot switch, push the travel/steer control handle forward and press the left button on the top of the handle with your thumb, and the machine will steer left.
2. Steer right: Depress the foot switch, push the travel/steer control handle forward and press the right button on the top of the handle with your thumb, and the machine will steer right.

### Traveling on Slopes

### WARNING

It is forbidden to travel on slopes, steps or arched surfaces that exceed the maximum allowable climbing angle.

Before traveling on a slope, please find out and determine:

1. the machine's gradeability.
2. the slope grade. To determine the slope grade:
  - Prepare an appropriate carpenter's ruler, a straight piece of wood and a tape measure.
  - Measure the height (H) and length (L) of the slope.

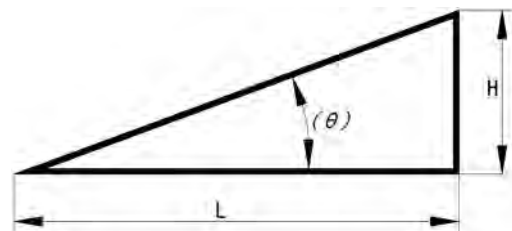

Fig 4

- Slope grade= H/L x 100%.

## WARNING

Do not drive the machine on the maximum permissible slope for over 2min to prevent the tires from running suspended.

## High/Low Travel Speed Switching

### WARNING

- The machine, if tilted, must be driven at low speed.
- Before traveling at high speed, be sure to observe whether the surrounding environment is safe, to avoid colliding with obstructions or persons and other hazards.

### NOTICE

Before switching to high travel speed mode, make sure the engine (if equipped) is running at high speed.

1. With the machine traveling in non-operating position, push upward the high/low drive speed selector switch, and the travel speed will be switched to high speed and the high drive speed indicator light will be on; push the travel control handle to full drive position, and the machine will travel at the maximum travel speed.

### NOTICE

- Before the machine traveling in non-operating position, if the high/low drive speed selector switch is left in high speed position, after the drive function is activated, the machine will start to run at high speed immediately.
- With the machine traveling in non-operating position, push upward the high/low drive speed selector switch, and the machine will start to run at high speed.

2. With the machine traveling in non-operating position, push downward the high/low drive speed selector switch, and the travel speed will be switched to low speed and the high drive speed indicator light will be out.
3. With the machine in operating position, the machine can only travel at low speed.

## 7.8 BOOM MOVEMENTS

### WARNING

Do not position the boom above the horizontal while driving the machine on surfaces exceeding the maximum allowable tilt angle.

### Perform operation from the ground:

1. **Raise the main boom:** Move and hold the enable switch, push the main boom luffing switch upwards, the main boom will be raised, and the pothole protection device will be deployed.
2. **Lower the main boom:** Move and hold the enable switch, pull the main boom luffing switch downwards, the main boom will be lowered, and the pothole protection device will be retracted.
3. **Extend the main boom:** Move and hold the enable switch, push the main boom telescope switch to the right, and the main boom will be extended.
4. **Retract the main boom:** Move and hold the enable switch, push the main boom telescope switch to the left, and the main boom will be retracted.
5. **Raise the articulated boom:** Move and hold the enable switch, push the articulated boom luffing switch upwards, the articulated boom will be raised, and the pothole protection device will be deployed.
6. **Lower the articulated boom:** Move and hold the enable switch, pull the articulated boom luffing switch downwards, the articulated boom will be lowered, and the pothole protection device will be retracted.
7. **Raise the jib boom:** Move and hold the enable switch, push the jib boom luffing switch upwards, and the jib boom will be raised. (if equipped)
8. **Lower the jib boom:** Move and hold the enable switch, pull the jib boom luffing switch downwards, and the jib boom will be lowered. (if equipped)
9. **Rotate the jib boom clockwise:** Move and hold the enable switch, pull downward the jib boom rotation switch, and the jib boom will rotate clockwise. (if equipped)
10. **Rotate the jib boom counterclockwise:** Move and hold the enable switch, push upward the jib boom rotation switch, and the jib boom will rotate counterclockwise. (if equipped)

### Perform operation from the platform:

1. **Raise the main boom:** Depress the foot switch, push the main boom luffing switch upwards, the main boom will be raised, and the pothole protection device will be deployed.
2. **Lower the main boom:** Depress the foot switch, pull the main boom luffing switch downwards, and the main boom will be lowered.

3. **Extend the main boom:** Depress the foot switch, pull the main boom telescope switch downwards, and the main boom will be extended.
4. **Retract the main boom:** Depress the foot switch, push the main boom telescope switch upwards, and the main boom will be retracted.
5. **Raise the articulated boom:** Depress the foot switch, push the articulated boom luffing switch upwards, the articulated boom will be raised, and the pothole protection device will be deployed.
6. **Lower the articulated boom:** Depress the foot switch, pull the articulated boom luffing switch downwards, the articulated boom will be lowered, and the pothole protection device will be retracted.
7. **Extend the articulated boom:** Depress the foot switch, push the articulated boom telescope switch upwards, and the articulated boom will be extended. (if equipped)
8. **Retract the articulated boom:** Depress the foot switch, pull the articulated boom telescope switch downwards, and the articulated boom will be retracted. (if equipped)
9. **Raise the jib boom:** Depress the foot switch, push the jib boom luffing switch upwards, and the jib boom will be raised. (if equipped)
10. **Lower the jib boom:** Depress the foot switch, pull the jib boom luffing switch downwards, and the jib boom will be lowered. (if equipped)
11. **Rotate the jib boom clockwise:** Depress the foot switch, push the jib boom rotation switch to the left, and the jib boom will rotate clockwise. (if equipped)
12. **Rotate the jib boom counterclockwise:** Depress the foot switch, push the jib boom rotation switch to the right, and the jib boom will rotate counterclockwise. (if equipped)

## 7.9 PLATFORM MOVEMENTS

### WARNING

The platform leveling function can only be used to slightly adjust the platform levelness in situations such as traveling up/down slopes. Improper use may cause loads/people to move or fall.

#### Perform operation from the ground:

1. **Level the platform upward:** Move and hold the enable switch, push upward the platform leveling switch, and the platform will be leveled upward.
2. **Level the platform downward:** Move and hold the enable switch, pull downward the platform leveling switch, and the platform will be leveled downward.

3. **Rotate the platform clockwise:** Move and hold the enable switch, pull downward the platform rotation switch, and the platform will rotate clockwise.
4. **Rotate the platform anti-clockwise:** Move and hold the enable switch, push upward the platform rotation switch, and the platform will rotate anti-clockwise.

#### Perform operation from the platform:

1. **Level the platform upward:** Depress the foot switch, push upward the platform leveling switch, and the platform will be leveled upward.
2. **Level the platform downward:** Depress the foot switch, pull downward the platform leveling switch, and the platform will be leveled downward.
3. **Rotate the platform clockwise:** Depress the foot switch, push the platform rotation switch to the left, and the platform will rotate clockwise.
4. **Rotate the platform anti-clockwise:** Depress the foot switch, push the platform rotation switch to the right, and the platform will rotate anti-clockwise.

## 7.10 AUXILIARY POWER

### NOTICE

- When the emergency power is in use, do not perform two or more functions at the same time, because certain function operation may have no response due to small flow in the emergency motor or pump.
- The emergency power switch can only be used for a short time (to fully lower and retract the platform from the maximum angle and maximum length) when the main power source is not working, because long-time operation may bring damage to the motor.

In the event of main power source failure, the auxiliary power can be used to perform the desired function operation.

#### Perform operation from the ground:

Move and hold the emergency power switch, activate the desired movement switch to perform the required function operation.

#### Perform operation from the platform:

Depress the foot switch, move and hold the emergency power switch, and activate the desired movement switch to perform the required function operation.

## 7.11 TRANSPORTATION AND LIFTING

The mobile elevating work platform is a non-road vehicle and is not licensed for on-road use, so this machine needs to be transported and transferred by road, railway or waterway.

**WARNING**

**Only qualified professionals can drive the machine onto or from the transport vehicle.**

Before transporting and lifting the machine:

1. Find out the total weight of the machine (see the machine nameplate or **Technical Parameters** section of this manual) and select appropriate lifting equipment, rigging and transport vehicle.
2. Make sure that the machine is stowed, the machine has no loose or unfixed parts, and no people or any tools are on the platform.
3. Ensure that the machine lifting points/rigging lashing points and their fixing structures are intact and that the belt or rope to be used has sufficient load strength.
4. Before loading/unloading the machine, ensure that the transport vehicle is parked on level ground and that the ramp used when driving the machine onto the trailer does not exceed the maximum climbing angle of the machine.
5. When loading/unloading the machine, the transport

vehicle must be secured to prevent it from moving.

6. The wheels should be locked after the machine is loaded to prevent it from moving.
7. Before releasing the brake, the machine must be parked on a horizontal surface or secured.
8. The machine can only be lifted from the specific position with a forklift or crane with sufficient lifting capacity. Care should be taken to prevent the machine from colliding with surrounding objects.

### Transportation

1. Adjust the machine to the transport position (the positions of the jib and platform in the following figure are for reference only, and can be adjusted as appropriate for the trailer during transportation).
2. Turn the key switch on the ground controller to OFF position and remove the key.
3. Firmly secure the chassis on the transport vehicle and take appropriate safety protection measures. Use at least 4 ropes or belts to secure the chassis and at least 1 rope or belt to secure the platform.
4. Adjust the rigging appropriately to prevent damage to the rope or belt.
5. To protect the boom, platform components and electrical and hydraulic components, do not apply excessive downward pulling force to the ropes or belts used to secure the platform. A foam layer can be placed under the platform and the bottom of the platform should be suspended.

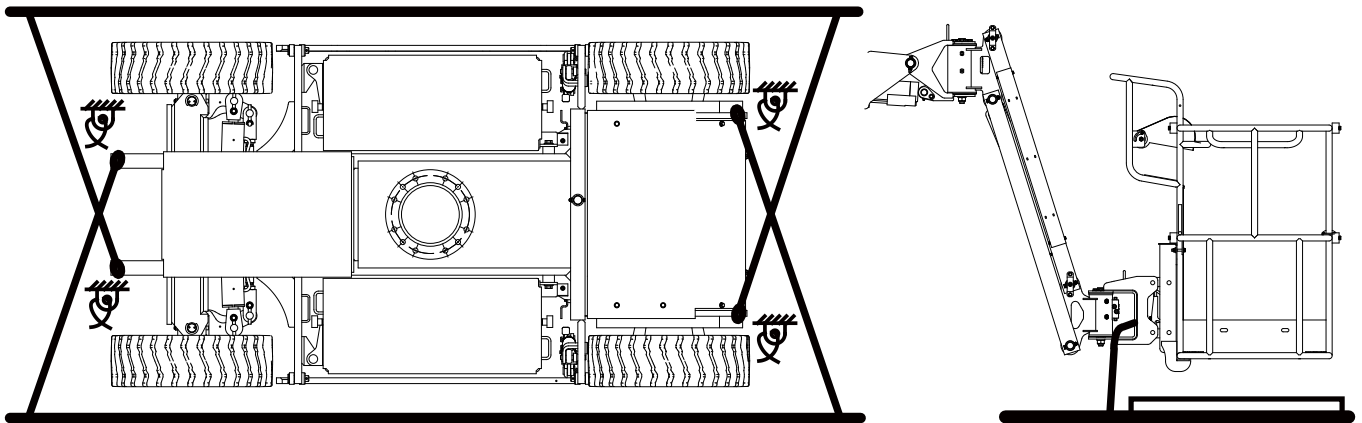

**Fig 5 Transportation diagram**

### Lifting

1. Determine the center of gravity of the machine.
2. The rigging must be attached to the lifting point specified on the machine.
3. Adjust the rigging properly to avoid damage to the machine and keep the machine level.

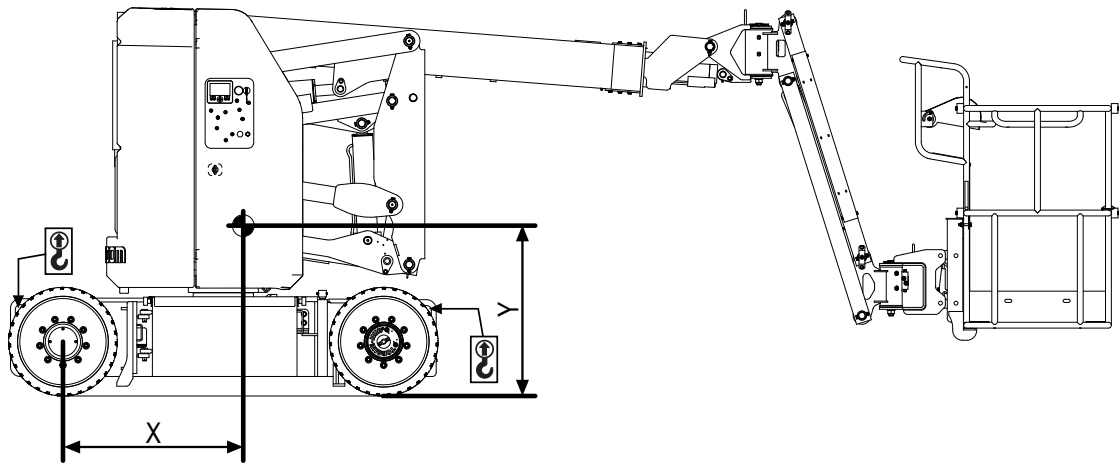

**Fig 6 Center of Gravity and Lifting Diagram**

X=927mm (3ft)

Y=876mm (2.87ft)

## 7.12 STORAGE

The mobile elevating work platform should be stored in rain-proof, moisture-proof and well-ventilated places free from sunlight and corrosive gas.

In order to ensure the normal use of the machine in future, the following measures should be taken when storing the machine:

1. Retract and lower the boom to the stowed position.
2. Close and lock all panels and gate locks on the machine.
3. Press the emergency stop switch on the ground controller and platform controller, turn the key switch to the OFF position and remove the key.
4. Press the main power switch.
5. Chock the wheels.
6. Wipe off the dust and oil from the machine to keep it clean.
7. Apply lubricating oil to corrosive parts.
8. When long-term storage is required, the fuel (if equipped with engine) and water should be drained, and the positive pole and negative pole of the battery should be disconnected.
9. When the machine is to be stored for more than three months, idle the machine every three months for not less than one hour each time, and clean and maintain the machine.
10. When the machine has been stored for more than one and a half years, a comprehensive inspection and maintenance on the whole machine should be

carried out before use, and aging seals and filter elements should be replaced according to the actual situation.

**This Page Intentionally Left Blank**

# 8

## EMERGENCY PROCEDURES

This chapter describes the steps to follow in the event of unexpected situations during operation.

### 8.1 REPORTING ACCIDENTS

In case of any accident involving the machinery of Hunan Sinoboom Intelligent Equipment Co., Ltd., notify Sinoboom immediately, even if there is no personal injury or property damage in the accident. Notify Sinoboom by phone and provide all necessary details.

Failure to notify the manufacturer within 48 hours of the incident involving the machinery of Sinoboom may void the product's warranty.

#### NOTICE

*Thoroughly inspect the machine and all its functions after any accident. Make sure to perform inspection first from the ground controller and then from the platform controller. Ensure the machine's lifting height does not exceed 3m (10ft) until all damage has been repaired and all controllers operate properly.*

### 8.2 EMERGENCY OPERATION

**When the operator is unable to control the machine (squeezed or trapped on the platform):**

1. Other personnel can only operate the machine from the ground controller according to the operation requirements.
2. Other qualified operation personnel on the platform can operate the platform controller. If the controller is not functional, stop operation.
3. Cranes, forklifts or other equipment that meet the requirements of use can be used to transport people on the platform and stabilize the movement of the machine.

**When the platform or elevating boom is stuck at height:**

If the platform or elevating boom is stuck or blocked by a high building or aerial equipment, rescue the operator on the platform firstly and then get the machine out.

**When the switch is reset but the movement does not stop:**

If any switch/handle returns to the neutral position and the corresponding movement does not stop, remove the foot from the foot switch or push in the emergency stop button to stop the machine.

### 8.3 EMERGENCY LOWERING

When the main power source fails, the emergency power on the ground controller or platform controller can be used according to the actual condition to lower the platform into place. Refer to the [Page 43, 7.10 Auxiliary Power](#) section for detailed procedures.

### 8.4 EMERGENCY TOWING

#### WARNING

- Unless in case of emergency situations, machine malfunction, power loss or loading/unloading, it is strictly prohibited to tow or drag the machine.
- The towing and dragging of the machine should follow local policies and road traffic laws.
- It is forbidden to tow the machine on highways.
- The machine does not have a brake for towing control, so the towing vehicle must be able to control the machine at all times, otherwise the machine may lose control, resulting in serious injury or death.
- The maximum permissible towing speed is 3km/h (1.9mph).
- The maximum permissible towing angle is 25%.
- The machine cannot be towed/dragged while the engine is working or the drive hub engages.
- Before the brake is released, the machine must be parked on a horizontal surface or secured.

1. Place the machine on solid level ground and secure the wheels with chocks to prevent the machine from moving.

2. Make sure that the boom is stowed, that the turntable is locked (if equipped with a rotation pin, that the rotation pin is locked), that the machine has no loose or unfixed parts, that there are no people or any tools on the platform, and that there are no obstacles on the surrounding passage.
3. Loosen the bolts on each drive hub and mount the drive hub cap reversely.

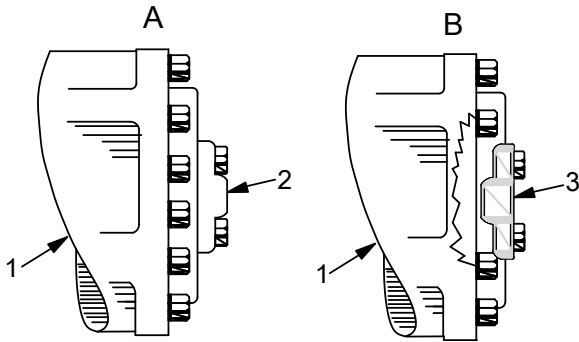

Fig 1

A Drive hub engaged      B Drive hub disengaged

- 1) Drive hub
  - 2) Disengage drive hub cap (obversely mounted)
  - 3) Disengage drive hub cap (reversely mounted)
4. Tighten the bolts, disengage the drive hub, and the machine can be towed and dragged by external force.
  5. After towing, place the machine on solid level ground and secure the wheels with chocks to prevent the machine from moving.
  6. Install the drive hub back to its original position, and tighten the bolts to make the drive hub engaged.

Then, the machine will activate the override function, and the corresponding movement can be performed. The time of the override operation and the actual weight on the platform are recorded on the display.

NOTICE

*Override function can only be used to lower the platform in an emergency state after the platform is overloaded, and before operating the machine to perform the required action, please confirm that the surrounding environment and the whole machine are safe.*

**WARNING**

**Before conducting any override operation, try to avoid operation in directions where the machine may tip over. Improper operation may cause the machine to overturn, causing serious machine damage and casualties.**

## 8.5 OVERRIDE FUNCTION

Override function is only applicable for overseas models.

With the machine in the KG mode, if an overload alarm is triggered and the platform needs to be lowered, the override function should be activated.

- Perform operation from the ground: Activate the desired movement switch while operating the emergency power switch on the ground controller;
- Perform operation from the platform: Depress the foot switch, operate the emergency power switch on the platform controller, and activate the desired movement switch.

# 9 DECALS DIAGRAM

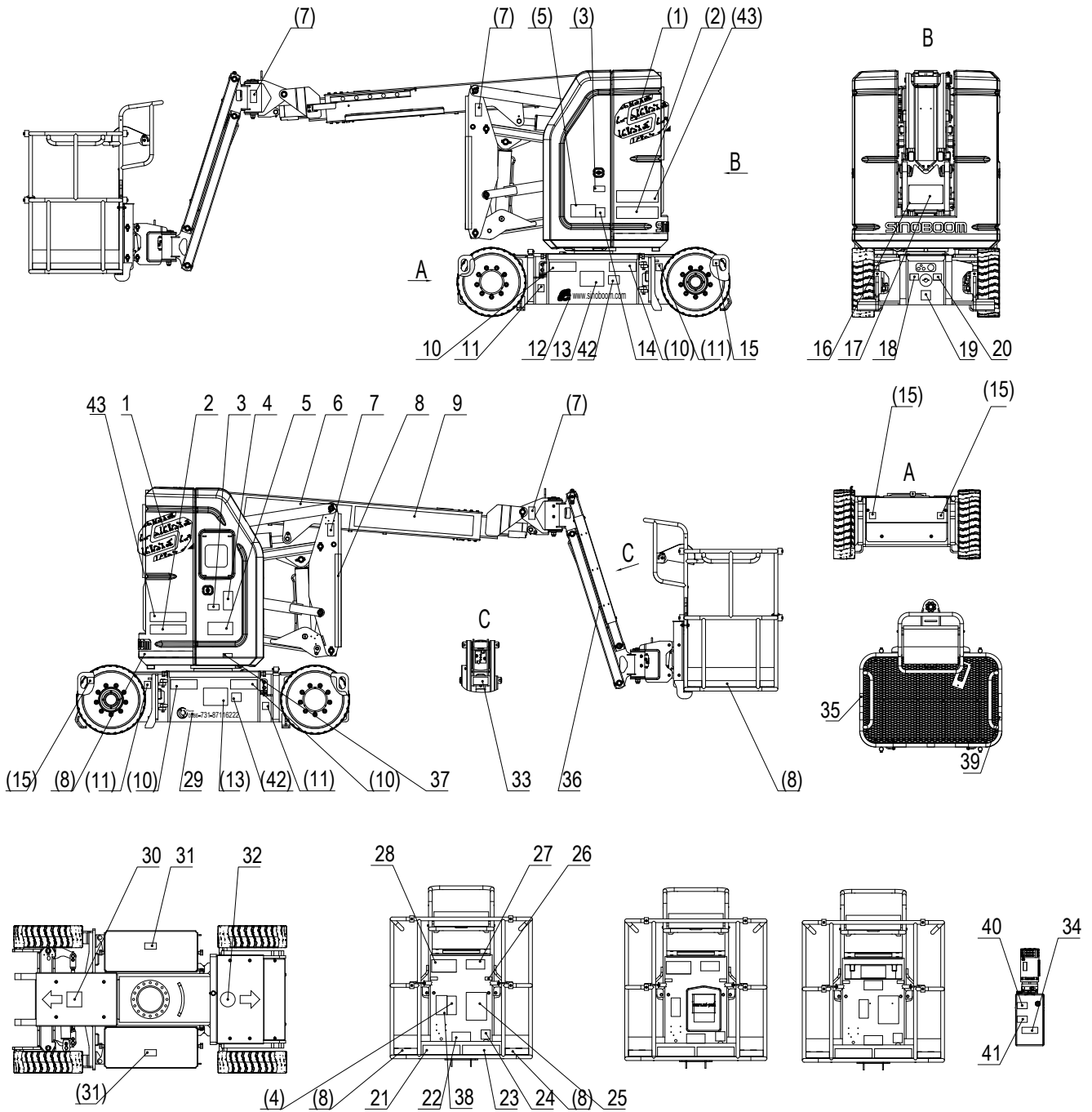

No.	GB	CE-Metric	CE-Imperial	AS	CSA	ANSI	Description
	103010103005	103010103007	103010103009	103010103010	103010103008	103010103006	Decals diagram
1	103008103006	103008103006	103008103006	103008103006	103008103006	103008103006	LOGO-Symbol
2	103010103002	103010103002	103010103012	103010103002	103010103012	103010103012	Decal-Trade ID
3	103010103015	103010103016	103010103016	103010103016	103010103016	103010103016	No rotating while the turn-table cover is opened
4	103010103000	103010103000	103010103000	103010103000	103010103000	103010103000	Decal-General safety instructions
5	104011100006	104011100006	104011100006	104011100006	104011100006	104011100006	Decal-Compartment overhaul
6	103010103003	103010103003	103010103011	103010103003	103010103011	103010103011	Decal-Trade ID
7	103009103009	103009103009	103009103009	103009103009	103009103009	103009103009	Decal-Crushing hazard
8	216060000002	216060000002	216060000002	216060000002	216060000002	216060000002	Yellow & black hazard warning stripe tape
9	105058103003	105058103003	105058103003	105058103003	105058103003	105058103003	LOGO-SINOBOOM (small)
10	104011100001	104011100001	104011100001	104011100001	104011100001	104011100001	Decal-Tipping hazard
11	103006103009	103006103009	103006103009	103006103009	103006103009	103006103009	Decal-Ground pressure 3580kg
12	103003100004	103003100009	103003100009	103003100009	103003100009	103003100009	Decal-Contact information
13	103010103017	103010103017	103010103017	103010103017	103010103017	103010103017	Decal-Recyclable logo Decal-Lead acid battery (GB only)
14	101016100034	101016100034	101016100034	101016100034	101016100034	101016100034	Decal-Noise level of 72dB
15	104011100002	104011100002	104011100002	104011100002	104011100002	104011100002	Decal-Lifting point
16	215050000001	215050000001	215050000001	215050000001	215050000001	215050000001	Blind rivet
17	105001100057	103010103019	103010103019	105018100005	103004103005	103004103005	Nameplate
18	101016100032	101016100032	101016100032	101016100032	101016100032	101016100032	Decal-Charging voltage
19	104011100016	104011100016	104011100016	104011100016	104011100016	104011100016	Decal-Emergency stop button
20	101012100010	101012100010	101012100010	101012100010	101012100010	101012100010	Decal-Electrocution hazard
21	103007103002	103007103002	103007103002	103007103002	103007103002	103007103002	Decal-Tipping hazard

No.	GB	CE-Metric	CE-Imperial	AS	CSA	ANSI	Description
22	104011100019	104011100019	104011100019	104011100019	104011100019	104011100019	Decal-Crushing hazard
23	103007103001	103007103001	103007103001	103007103001	103007103001	103007103001	Decal-Rated platform capacity of 230kg
24	104011100017	104011100017	104011100017	104011100017	104011100017	104011100017	Decal-Foot switch
25	103010103004	103010103004	103010103004	103010103004	103010103004	103010103004	Decal-Diagram of working envelope
26	101048100014	101016100030	101016100030	101016100030	101016100030	101016100030	Decal-Anchorage point
27	104011100009	104011100009	104011100009	104011100009	104011100009	104011100009	Decal-Read manuals
28	104011100015	104011100015	104011100015	104011100015	104011100015	104011100015	Decal-Tipping hazard
29	103003100013	103003100015	103003100015	103003100015	103003100015	103003100015	Decal-Contact information
30	103006103011	103006103011	103006103011	103006103011	103006103011	103006103011	Decal-Direction marking
31	101012100001	101012100001	101012100001	101012100001	101012100001	101012100001	Decal-No smoking or open flames
32	103003100010	103003100010	103003100010	103003100010	103003100010	103003100010	Decal-Direction marking
33	103010103001	103010103001	103010103001	103010103001	103010103001	103010103001	Decal-Fall hazard
34	104009100018	104009100022	104009100022	104009100022	104009100022	104009100022	Decal-Hydraulic oil marking
35	104011100021	104011100021	104011100021	104011100021	104011100021	104011100021	Decal-Crushing hazard
37	/	/	/	/	101040103015	101040103015	Decal-Annual inspection date
38	/	/	/	/	105029103023	105029103023	Decal-Operation instructions
39	/	/	/	/	103010103014	103010103014	Decal-Non-insulated
40	104011100010	104011100010	104011100010	104011100010	104011100010	104011100010	Decal-Hydraulic oil level
41	104011100003	104011100003	104011100003	104011100003	104011100003	104011100003	Decal-Hydraulic oil level
42	103010103018	/	/	/	/	/	Decal-QR code (small)
43	105068103021	/	/	/	/	/	Decal-NEO (small)

**This Page Intentionally Left Blank**

# 10 MAINTENANCE

This chapter provides the operator with the additional information needed to properly operate and maintain the machine and is only intended to assist the operator in performing routine maintenance tasks. For more comprehensive maintenance instructions, please refer to the **Inspection and Preventive Maintenance Schedule** and the Maintenance Manual.

## 10.1 LUBRICATION

In order to ensure the performance and service life of the machine and its components, the moving parts must be regularly inspected and lubricated.

### NOTICE

- *Mixing lubricating oil of different grades will change its property, and bring damage to the machine. When adding lubricating oil, the oil to be added must have the same grade as that of the oil being used by the machine.*
- *Using lubricating oil mixed with dust can lead to premature wear of the sliding surfaces and shorten the service life of the machine. Before adding lubricating oil, the oil cup and other surfaces must be cleaned.*
- *Failure to comply with lubrication intervals or lack of lubrication can cause machine damage and increase repair costs and downtime.*

### WARNING

- **During machine lubrication, unrelated personnel are prohibited from operating the machine, because accidental operation of the machine may bring serious danger to the operator.**
- **If lubricating oil gets into the eyes, rinse the eyes immediately with clean water and seek medical attention in time. If the skin comes into contact with lubricating oil, make sure to thoroughly wash the skin with water.**

Table 10-1

No.	Position	Interval	Lubricating oil/grease grade	Operation
1	Travel drive device	Every 3 months or 250 working hours	Refer to the <b>Gear Oil</b> section	Check oil level
		Every 1 year or 1000 working hours		Replace oil
2	Slewing drive device	Every 3 months or 250 working hours	Refer to the <b>Gear Oil</b> section	Check oil level
		Every 1 year or 1000 working hours		Replace oil

Table 10-1 (Continued)

No.	Position	Interval	Lubricating oil/grease grade	Operation
3	Slewing bearing	Every 3 months or 250 working hours	ZL-3 lithium-based lubricating grease	Add oil with oil gun

Note: If the machine uses integrated slewing bearing (including both the slewing drive device and slewing bearing) to perform the rotation movement, just conduct inspection and lubrication as per the requirements of No.3 in the table.

Lubrication intervals are based on machine usage under normal operating conditions, and if the machine is used in harsh conditions (such as dusty environments) or abnormal conditions, the inspection and lubrication should be performed more frequently.

### Hydraulic Oil

The hydraulic oil filled when the machine leaves the factory is generally L-HV32 or L-HM46 or other hydraulic oil required by customers. The environment temperature varies from region to region, so choose the hydraulic oil suitable for your region as suggested by the following table.

## 10.2 OIL REQUIREMENTS

### NOTICE

- Please choose appropriate oil according to the ambient temperature and local regulations, and the use of unqualified oil will damage the machine components.
- Oils of different grades or viscosities should not be mixed. The oil to be added must have the same grade and viscosity as that of the oil being used by the machine.
- If special oil is required by the environments or users, please contact Sinoboom.

### WARNING

- Before filling oil, wait until the temperature of the machine drops to room temperature, otherwise it may cause splashes, burns or other personal injury.
- It is strictly forbidden to use inferior oils. The use of inferior oils will bring damage to the machine, and the resulting failure will not be guaranteed by Sinoboom.

Table 10-2

Applicable environment temperature	amer	Mobil	Shell	Castrol
> 40°C (104°F)	L-HM46	DTE 10 Excel 46	S2M46	Hyspin AWH-M46
-25°C ~ 40°C (-13°F ~ 104°F)	L-HV32	DTE 10 Excel 32	TELLUS-S3VE32	Hyspin HVI-32
< -30°C (-22°F)	Special oil to be determined.			

### Gear Oil

The machine uses industrial gear oil with the viscosity grade of 75W-90.

## 10.3 TIRE ASSEMBLY

### Check Tires and Rims

Check the tires and rims daily and replace the tire if any of the following defects is found:

- The tire is severely cracked, broken, deformed or has other abnormalities.
- The tire ply has a smooth, uniform cut with a total length of more than 75mm (3in).
- The tire ply has a crack or fissure that exceeds 25mm (1in) in either direction.
- The tire has a perforation with the diameter of over 25mm (1in).
- The tire has a large bulge.
- The wear extent of the tire's off-ground support surface exceeds 25%.

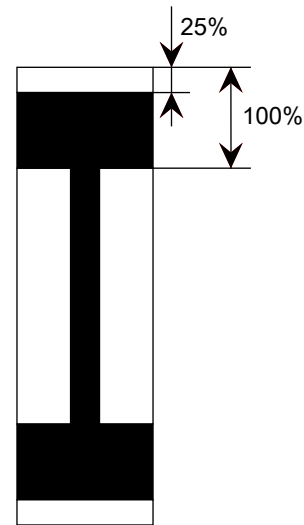

Fig 1

### Check Wheel Fasteners

The wheel fasteners should be tightened before the machine is put into service for the first time and after each tire is removed. Check and tighten the wheel fasteners to the specified torque every 3 months or 250 working hours.

## Replacement Requirements

### WARNING

- The tires and rims on the machine have been designed and selected according to the overall performance and load stability requirements of the machine, so their models, rim width, installation center surface, diameter, etc. must not be changed, otherwise it may result in an unsafe condition regarding stability.
- Use the special wheel nut that suits the rim bolt. The wheel nuts must be installed and maintained with the proper tightening torque to prevent loose rims, broken studs and tire detachment from the axle. Be sure to only use the nut that matches the cone angle of the wheel.

Hunan Sinoboom Intelligent Equipment Co., Ltd. recommends the replacement tire be of the same size, ply rating and brand as the original tire. For the tire part number of a specific machine model, please reference its Parts Manual. If the replacement tire is not as Hunan Sinoboom Intelligent Equipment Co., Ltd. recommends, the following requirements should be met:

- With the ply rating/rated load capacity and dimension equal to or greater than the original.
- With the tire tread contact width equal to or greater than the original.
- With the wheel diameter, width and offset dimensions equal to the original.
- Approved for the application by the tire manufacturer (including intended purposes, maximum drive speed and maximum tire load, etc.).
- Due to the size difference between different tire brands, both tires on the same axle should be of the same brand.

### NOTICE

*Unless specifically approved by Sinoboom, do not replace foam-filled tires with pneumatic tires.*

## Replace Tires

### WARNING

**Tighten the nut to the proper torque to prevent the tire from loosening. Use a torque wrench to tighten the fastener, if you don't have a torque wrench, use a socket wrench to tighten the fastener and then immediately have a service station or dealer to tighten the fastener to the correct torque. Over-tightening will cause the bolts to break or permanently deform the bolt holes in the tires.**

The correct steps to replace a tire are as follows:

1. Make sure the machine is in stowed position.
2. Press the main power switch and disconnect all power sources (such as battery charger) connected to the machine.
3. Use a wrench to loosen but do not remove the tire retaining nut.
4. Use a jack with sufficient load capacity to lift the machine frame to the appropriate height so that the tire assembly is off the ground.
5. Remove the tire retaining nuts and bolts alternately, and then remove the tire.
6. Align the mounting hole of the new tire with the corresponding mounting hole in the frame.
7. After applying Loctite 272 threadlocking adhesive to the bolts and nuts, install the bolt and nuts sequentially.
8. Tighten all nuts by hand first to prevent loosening of the bolts and nuts. Never apply lubricant to threads or nuts.
9. Then tighten the nuts step by step in the order as shown below. Please refer to the recommended torque in the table below for tightening.

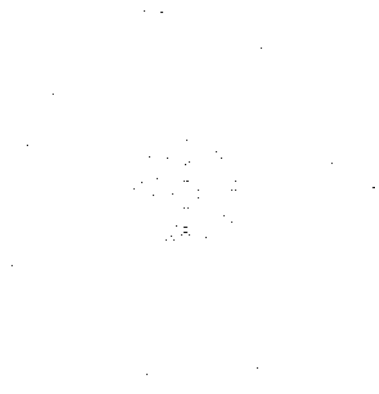

Fig 2 Diagram of wheel nuts tightening sequence

Table 10-3 Table of front wheel nuts tightening torque

First step	Second step	Third step
100Nm (74ft-lb)	180Nm (133ft-lb)	246Nm (182ft-lb)

Table 10-4 Table of rear wheel nuts tightening torque

First step	Second step	Third step
100Nm (74ft-lb)	200Nm (148ft-lb)	283Nm (209ft-lb)

## 10.4 INSPECTION AND PREVENTATIVE MAINTENANCE SCHEDULE

This section provides safety and other necessary information for machine operators. For maximum service life and safe operation of the machine, ensure that all necessary inspection and maintenance works have been completed before placing the machine into service.

It is quite important to establish and implement a comprehensive inspection and preventive maintenance schedule. This manual outlines the frequent inspection and maintenance works recommended by Hunan Sinoboom Intelligent Co., Ltd. Consult your national, regional or local regulations for aerial work platforms. The frequency of the inspection and maintenance must be increased as required by the environment, requirements and frequency of usage.

### Pre-delivery Inspection

The pre-delivery inspection shall be performed by qualified Sinoboom equipment mechanics.

The pre-delivery inspection shall be performed before each sale, lease or rental delivery.

Refer to the **Inspection and Preventative Maintenance Schedule** for items requiring this inspection. Refer to the corresponding section of this manual to perform the inspection and maintenance procedures.

### Pre-operation Inspection

Before each start of work, restart of work and change of user, and after each maintenance operation, the pre-operation inspection must be performed. Refer to the Pre-operation Inspection section of the Operation Manual for the detailed information. The Operation Manual must be entirely read and understood before performing the pre-operation inspection.

### Frequent Inspection

The frequent inspection shall be performed by qualified Sinoboom equipment mechanics.

The frequent inspection shall be performed for each machine in service for 3 months or 150 hours (whichever comes first) or out of service for more than 3 months. The frequency of this inspection must be increased as required by the environment, requirements and frequency of usage.

The items included in the frequent inspection are the same as those in the pre-delivery inspection.

### Annual Machine Inspection

An annual machine inspection must be performed once a year and no later than 13 months from the date of the prior annual machine inspection. Hunan Sinoboom Intelligent Equipment Co., Ltd. recommends this task be performed by a factory-trained service technician, a person recognized by Sinoboom as one who, by possession of a recognized degree, certificate and training, has successfully demonstrated the ability and proficiency to service, repair and maintain the subject Sinoboom product model.

Refer to the **Inspection and Preventive Maintenance Schedule** for items requiring this inspection, and refer to the corresponding section of this manual to perform inspection and maintenance procedures.

## Preventive Maintenance

The preventive maintenance operation shall be performed by qualified Sinoboom equipment mechanics. The frequency of the inspection and maintenance must be increased as required by the environment, requirements and frequency of usage.

Refer to the **Inspection and Preventative Maintenance Schedule** for items requiring this inspection. Refer to the corresponding section of this manual to perform the inspection and maintenance procedures.

## Responsible Persons and Qualifications for Performing Inspection and Maintenance

Table 10-5

Inspection Type	Inspection Frequency	Primary Responsible Persons	Service Qualifications
Pre-operation Inspection	Before each start of work, restart of work and change of user, and after each maintenance operation	User or operator	Properly trained user or operator
Pre-delivery Inspection	Before each sale, lease or rental delivery	Owner, dealer or user	Qualified Sinoboom mechanic
Frequent Inspection	In service for 3 months or 150 hours (whichever comes first) or out of service for more than 3 months	Owner, dealer or user	Qualified Sinoboom mechanic
Annual Machine Inspection	Once a year and no later than 13 months from the date of the prior annual machine inspection	Owner, dealer or user	Factory-trained service technician
Preventive Maintenance	At intervals specified in the <b>Inspection and Preventative Maintenance Schedule</b>	Owner, dealer or user	Qualified Sinoboom mechanic

## Inspection and Preventative Maintenance Schedule

Perform inspection and preventive maintenance for the items in the table below at prescribed intervals. The intervals of inspection and maintenance are calculated based on the months elapsed since the machine has been put into service or the “cumulative working time” on the turntable controller display (whichever comes first).

The inspection cycle is based on the use of machine under normal working conditions, and the cycle should be shortened accordingly if the machine is used in harsh working conditions.

Table 10-6 Inspection and Preventative Maintenance Schedule

Items	Intervals		
	Before each delivery <sup>1</sup> or quarterly <sup>2</sup>	Semiannually <sup>3</sup>	Annually <sup>4</sup>
<b>Chassis assembly</b>			
Chassis	2	2	2
Tire	1, 2	1, 2	1, 2
Wheel fastener	150	150	150
Travel motor	1, 2	1, 2	1, 2
Travel reducer	1, 2, 6	1, 2, 6	1, 2, 6, 11

**Table 10-6 Inspection and Preventative Maintenance Schedule (Continued)**

Items	Intervals		
	Before each delivery <sup>1</sup> or quarterly <sup>2</sup>	Semiannually <sup>3</sup>	Annually <sup>4</sup>
Steering component	1, 2	1, 2	1, 2
Outrigger, telescopic shaft (if equipped)	1, 2, 3	1, 2, 3	1, 2, 3
Bearing	1, 2, 5, 12	1, 2, 5, 12	1, 2, 5, 12
<b>Turntable assembly</b>			
Turntable	2	2	2
Slewing bearing or slewing reducer	1 <sup>50</sup> , 2, 6, 12	1 <sup>50</sup> , 2, 6, 12	1 <sup>50</sup> , 2, 6, 8, 12
Slewing reducer (if equipped)	1, 2, 6	1, 2, 6	1, 2, 6, 11
Central rotary joint	6	6	6
Slewing motor	1, 6	1, 6	1, 6
Turntable pin (if equipped)	1, 2, 3	1, 2, 3	1, 2, 3
Turntable cover assembly	1, 2, 3	1, 2, 3	1, 2, 3
<b>Boom assembly</b>			
Boom weldment	1, 2	1, 2	1, 2
Hose or wire rope bracket	1, 2	1, 2	1, 2
Pulley and slider assembly	1, 2	1, 2	1, 2
Bearing	1, 2, 5, 12	1, 2, 5, 12	1, 2, 5, 12
Cover or protective guard (if equipped)	1, 2	1, 2	1, 2
Drag chain or wire rope system (if equipped)	1, 2, 3, 5	1, 2, 3, 5	1, 2, 3, 5
Pivot pin and retaining ring	1, 2	1, 2	1, 2
<b>Platform assembly</b>			
Guardrail	2	2	2
Access gate	1, 2, 3	1, 2, 3	1, 2, 3
Floor	2	2	2
Swing cylinder	1, 2, 5, 6	1, 2, 5, 6	1, 2, 5, 6
Safety belt anchorage point	1, 2, 7	1, 2, 7	1, 2, 7
<b>Hydraulic system</b>			
Hydraulic pump	1, 2, 6	1, 2, 6	1, 2, 6
Hydraulic cylinder	1, 2, 5, 6	1, 2, 5, 6	1, 2, 5, 6
Oscillating cylinder exhausting (if equipped)	10 <sup>NO.1</sup>	10 <sup>NO.1</sup>	10 <sup>NO.1</sup>
Hydraulic valve	1, 2, 5, 6	1, 2, 5, 6	1, 2, 5, 6

**Table 10-6 Inspection and Preventative Maintenance Schedule (Continued)**

Items	Intervals		
	Before each delivery <sup>1</sup> or quarterly <sup>2</sup>	Semiannually <sup>3</sup>	Annually <sup>4</sup>
Counterbalance valve locking check (if equipped)	10 <sup>NO.1</sup>	10 <sup>NO.1</sup>	10 <sup>NO.1</sup>
Hydraulic connecting pin and retaining ring	1, 2	1, 2	1, 2
Hydraulic hose, pipeline and joint	1, 2, 6	1, 2, 6	1, 2, 6
Hydraulic tank, cap and vent	1, 2, 3, 5, 6	1, 2, 3, 5, 6	1, 2, 3, 5, 6
Hydraulic oil filter	1, 5, 6	1, 5, 6, 11 <sup>50</sup>	1, 5, 6, 11 <sup>50</sup>
Hydraulic oil	5, 6	5, 6	5, 6, 11
<b>Electrical system</b>			
Electrical wiring, connector	1, 2	1, 2	1, 2
Battery	1, 2, 6, 9, 12	1, 2, 6, 9, 12	1, 2, 6, 9, 12
Electrolyte	6	6	6
Charging function	3	3	3
Instrument, meter, switch, lamp, horn	1, 3	1, 3	1, 3
<b>Functions and controls</b>			
Platform controller	1, 3, 4, 7, 10	1, 3, 4, 7, 10	1, 3, 4, 7, 10
Turntable controller	1, 3, 4, 7, 10	1, 3, 4, 7, 10	1, 3, 4, 7, 10
Function control lock, protective device and brake	1, 3, 10	1, 3, 10	1, 3, 10
Foot switch	1, 3, 10	1, 3, 10	1, 3, 10
Emergency stop button (ground and platform)	1, 3, 10	1, 3, 10	1, 3, 10
Limit switch and main power switch	1, 3, 10	1, 3, 10	1, 3, 10
Pothole protection device (if equipped)	1, 3, 10	1, 3, 10	1, 3, 10
Overload limit system	1, 3, 10	1, 3, 10	1, 3, 10
Tilt alarm device	1, 3, 10	1, 3, 10	1, 3, 10
Drive brake	1, 3, 10	1, 3, 10	1, 3, 10
Rotation brake	1, 3, 10	1, 3, 10	1, 3, 10
<b>Other inspection items</b>			
Operation Manual in the manuals storage box	10	10	10
All decals/labels complete, clear and secure	10	10	10
Annual inspection date of the machine	/	/	10

**Table 10-6 Inspection and Preventative Maintenance Schedule (Continued)**

Items	Intervals		
	Before each delivery <sup>1</sup> or quarterly <sup>2</sup>	Semiannually <sup>3</sup>	Annually <sup>4</sup>
No unapproved changes or additions	10	10	10
All safety publications included	10	10	10
General structural components and welds	2	2	2
All fasteners, pins, protective guards and covers	1, 2	1, 2	1, 2
Grease and lubricating to specifications	10	10	10
Functional test of all systems	10	10	10
Paint and appearance	5	5	5
Inspection date stamped on the chassis	/	/	10
Notify Sinoboom of machine ownership	/	/	10

**Table 10-6 Inspection and Preventative Maintenance Schedule (Continued)**

Items	Intervals		
	Before each delivery <sup>1</sup> or quarterly <sup>2</sup>	Semiannually <sup>3</sup>	Annually <sup>4</sup>
<p>Note:</p> <p><sup>1</sup> Before each sale, lease or shipment;</p> <p><sup>2</sup> In service for 3 months or 250 hours; or out of service for more than 3 months;</p> <p><sup>3</sup> In service for 6 months or 500 hours;</p> <p><sup>4</sup> Once a year and no later than 13 months from the date of the prior annual machine inspection;</p> <p><sup>50</sup> The first inspection work shall be performed after the machine has been in service for 50 hours for the first time; This only happens once in the service life of the machine;</p> <p><sup>250</sup> The first inspection work shall be performed after the machine has been in service for 250 hours for the first time. This only happens once in the service life of the machine.</p> <p>NO.1 Before the machine is put into service for the first time, or before the first use after the oscillating cylinder or counterbalance valve is replaced.</p>			
<p>Performance code:</p> <ol style="list-style-type: none"> <li>1. Check for correct installation (accurate position, firmly installed, tightened according to the specified torque)</li> <li>2. Visual inspection for damage (cracks, cracked welds, deformation, wear, corrosion, excessive wear, gouges, abrasions and exposed threads)</li> <li>3. Check for normal function</li> <li>4. Return to neutral position or “off” position normally (the self-reset switch can return to neutral position or “off” position after released)</li> <li>5. Clean and free of foreign objects</li> <li>6. Check for correct sealing, leaking and level</li> <li>7. Labels complete, clear and secure</li> <li>8. Check for appropriate tolerances</li> <li>9. Fully charged</li> <li>10. Validation/Execution</li> <li>11. Replace the oil or filter element</li> <li>12. Correctly lubricated</li> </ol>			



# 11 OPTIONS

## 11.1 SECONDARY GUARDING

Self-propelled boom-supported elevating work platforms are designed to transport people, tools and materials to aerial workplaces. When the operator stands on the platform to operate the machine with the back facing the telescoping direction of the boom and the head facing the elevating direction of the boom, due to failure to notice obstacles behind or overhead in time or accidental operation, life-threatening dangers may result. The Secondary Guarding can protect the operator by preventing the operator from being pinched.

 **WARNING**

**Unsafe Operation Hazard**

- Except for designated models and corresponding markets, it is forbidden to install the Secondary Guarding on other Sinoboom products or any models in other markets.**
- Before using the Secondary Guarding, the safety rules and all operating instructions should be read, understood and observed. This manual should always be kept with the Secondary Guarding as a part of it.**

Fig 1

Table 11-1

No.	Part Number	Part Name	Quantity	Comment
1	203080000101	Waterproof cap	1	
2	203080000109	Slotted nut	1	
3	203060000021	Toggle switch	1	
4	203060000150	Toggle switch guard	1	If equipped

Device Components

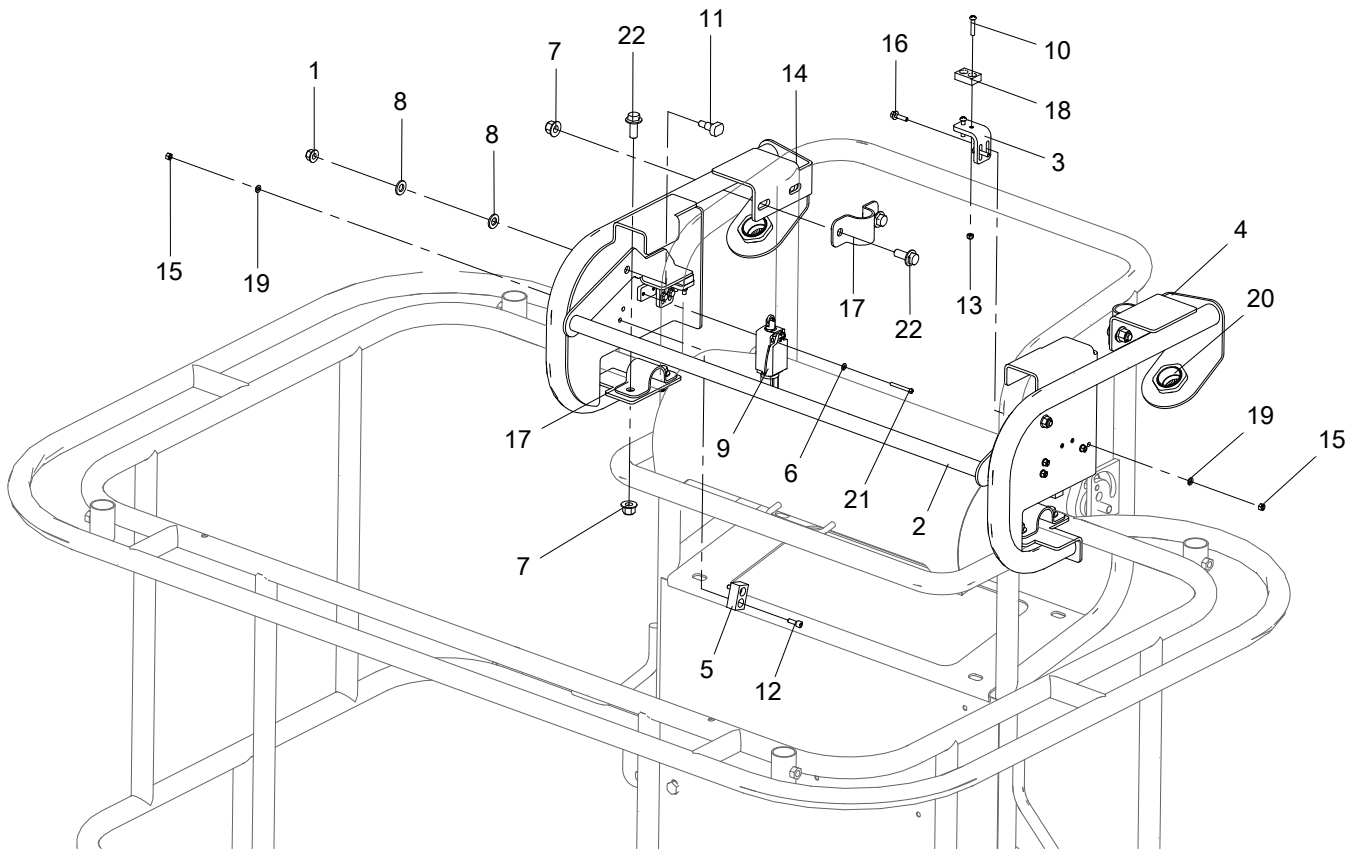

Fig 2

Table 11-2

No.	Part Number	Part Name	Quantity	Comment
1	215030000108	Nut M8-8-ZnD GB/T 6183	2	
2	105070043011	Support	1	
3	105070043028	Foldable plate	2	
4	105070043030	Support	1	
5	103010013495	Cushion block	2	
6	215040000031	Washer 4-A2 GB/T 97.1	4	
7	215030000109	Nut M10-8-ZnD GB/T 6183	8	
8	215040000035	Washer 10-200HV-ZnD GB/T 97.1	4	
9	203060003031	Travel switch (Schneider)	2	
10	215020000113	Screw M5×25-A2-70 GB/T 818	4	
11	105070043031	Bolt	2	
12	215020000007	Screw M5×16-A2-70 GB/T 70.1	4	
13	215030000091	Nut M5-8-A2-70 GB/T 6184	4	
14	105070043032	Support	1	
15	215030000003	Nut M5-A2-70 GB/T 6170	8	

Table 11-2 (Continued)

No.	Part Number	Part Name	Quantity	Comment
16	215010000256	Bolt M5×20-8.8-ZnD GB/T 5789	4	
17	105029043013	Plate	4	
18	209990003011	Magnet	2	
19	215040000032	Washer 5-A2 GB/T 97.1	12	
20	203050003058	Strobe light	2	
21	215020000212	Screw M4×35-A2-70 GB/T 818	4	
22	215010000238	Bolt M10×25-8.8-ZnD GB/T 5789	8	

### Installation and Removal

 **WARNING**

**Unsafe Operation Hazard**

**Except for designated models and corresponding markets, it is forbidden to install the foot switch on other Sinoboom products or any models in other markets.**

#### Installation instructions

1. Position the support (#4 or #14) at the mounting position on the platform railing, align the support with the mounting hole on mounting plate #17, and use bolts and nuts to secure the support to the platform railing. Install the support on the other side of the platform in the same way.
2. Align the folded plate #3 with the mounting holes on the left and right supports, tighten it with bolts, washers and nuts, and install the magnet #18 on the foldable plate.
3. Then align the support #2 with the mounting holes on the left and right supports, and make the folded plates on both sides of support #2 attracted by magnets, and tighten it with bolts, washers and nuts.
4. Install the cushion block #5 on the left and right supports in turn, and tighten it with screws, washers and nuts.
5. Install the travel switch #9 on the left and right supports in turn, and tighten it with screws and washers.
6. Install the strobe light #20 on the left and right

supports in turn.

7. Connect the Secondary Guarding harness.

#### Removal instructions

Disassemble the Secondary Guarding in the reverse order of the installation instructions.

### Instructions for Use

1. Under normal circumstances, the foldable plates on both sides of support #2 will be attracted by the magnets below.
2. Press down the railing of support #2 so that the foldable plates on both sides detach from the magnets and cock up, and the travel switch will be disconnected, the left and right strobe lights will flash, and all functions on the platform controller will be disabled.
3. Depress the foot switch while operating the release switch on the platform controller, and the boom can be retracted and lowered, and the turntable can rotate slowly.
4. To enable the boom extending and elevating functions, lift the railing of support #2 up until the foldable plates on both sides are re-attracted by the magnets and the strobe light goes out.



**Table 11-3**

<b>No.</b>	<b>Part Number</b>	<b>Part Name</b>	<b>Quantity</b>	<b>Comment</b>
1	203080000405	Sheath	1	
2	203080000046	Lock	1	
3	203080000033	Tape-on-reel male terminal	5	
4	203080000466	Tail clamp (3-pin, male)	1	
5	203080003313	Thin-walled automotive wires	2	
6	203080003326	Thin-walled automotive wires	1	
7	203080000564	Thin-walled automotive wires (white)	5	
8	203080000410	Sheath	2	
9	203080000016	Lock	2	
10	203080000041	Tape-on-reel female terminal	8	
11	203080000437	Tail attachment (2-pin, female)	2	
12	203080000448	Rubber connector (2-pin)	2	
13	203080000417	Nylon hose (closed-end)	1	
14	203080000424	Nylon hose (closed-end)	1	
15	203080000563	Thin-walled automotive wires (black)	1	
16	203080000562	Thin-walled automotive wires (red)	1	
17	203080000408	Sheath	1	
18	203080000021	Lock	1	
19	203080000462	Tail attachment (2-pin, male)	1	
20	203080000044	Sheath	2	
21	203080000020	Lock	2	
22	203080000445	Tail attachment (4-pin, female)	2	
23	203080000446	Rubber connector (4-pin)	2	



### Wiring Diagram of Platform Controller

The diagram below only shows the wiring related to the Secondary Guarding, and the complete wiring layout can be found in the complete platform controller wiring diagram.

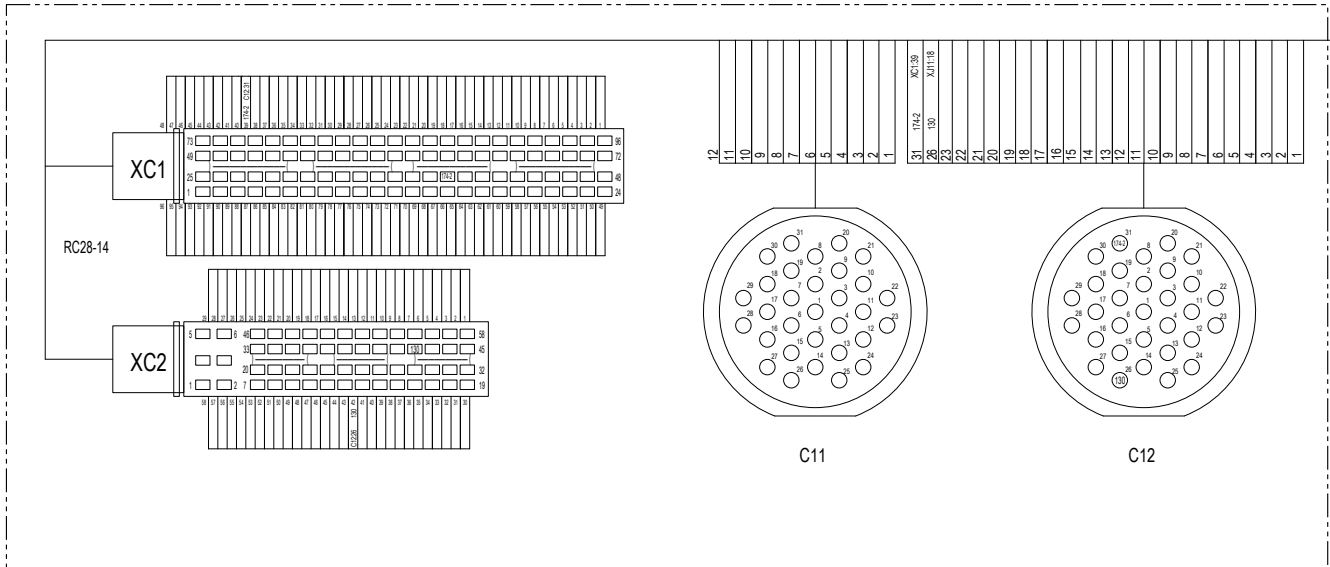

Fig 5

### Platform Harness

The figure below only shows the platform harness related to Secondary Guarding, and the complete harness layout can be found in the complete platform harness diagram.

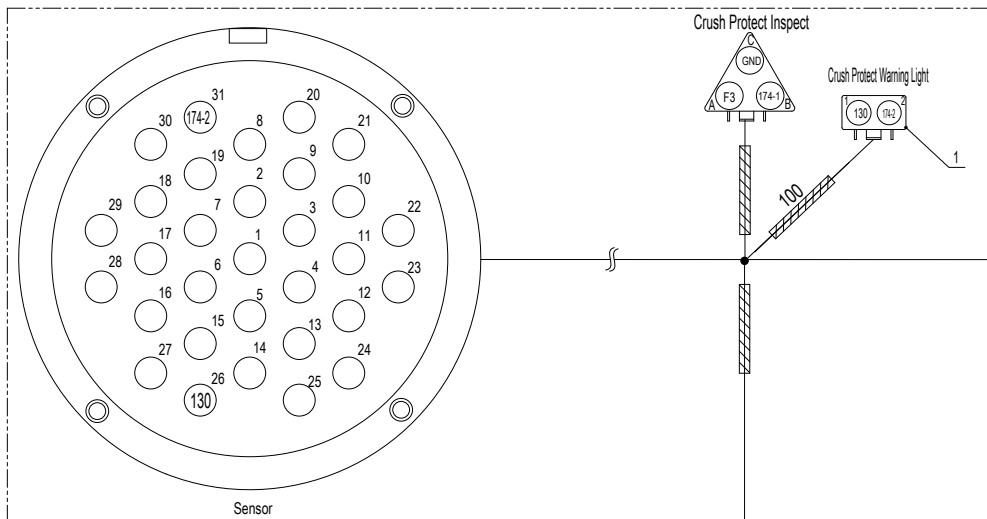

Fig 6

Table 11-4

No.	Part Number	Part Name	Quantity	Comment
1	203080000474	Waterproof cap (2-pin, female terminal)	1	

**Electrical Schematic Diagram of Platform**

The diagram below only shows the electrical schematic related to the Secondary Guarding, and the complete electrical schematic can be found in the complete electrical schematic diagram of platform.

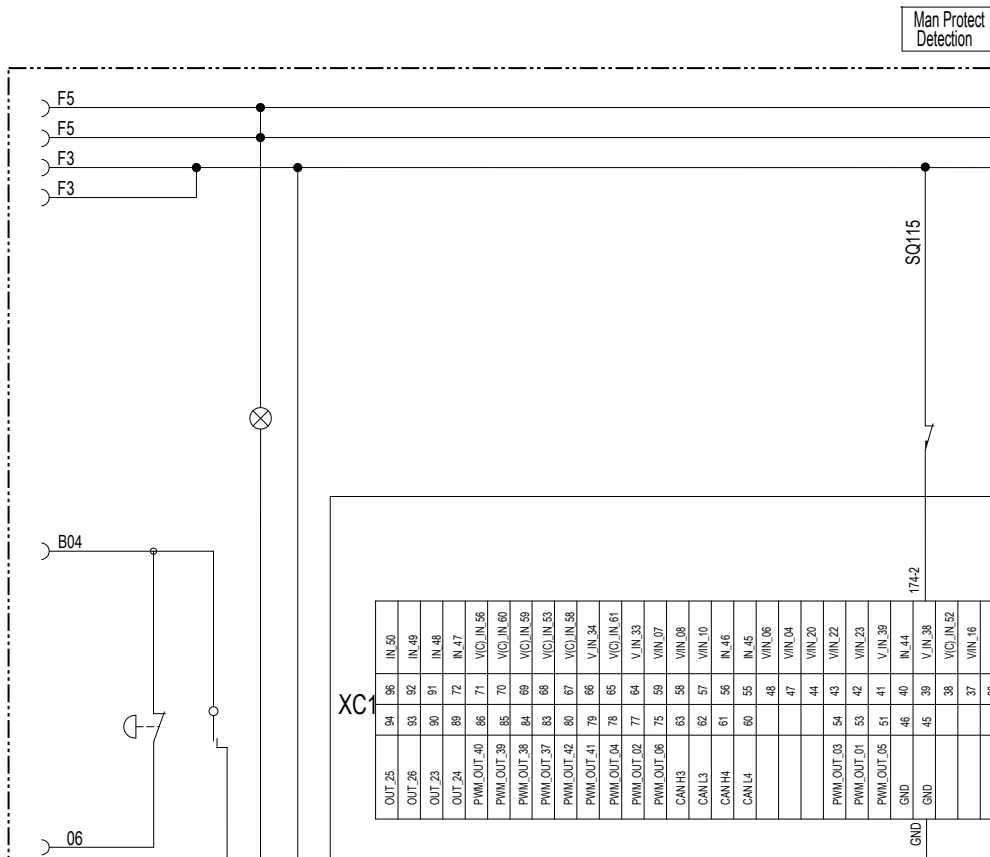

Fig 7



## 11.2 PIPE CRADLE

### Parts List

Self-propelled boom-supported elevating work platforms are designed to transport people, tools and materials to aerial workplaces. When it is needed to transport the pipe materials to an aerial position, the pipe cradle serves as a supporting unit to hold and secure the pipe materials for safe transport.

⚠ **WARNING**

Unsafe Operation Hazard

- Except for designated models and corresponding markets, it is forbidden to install the pipe cradle on products with other models or in other markets than specified.
- Before using the pipe cradle, the safety rules and all operating instructions should be read, understood and observed. This manual should always be kept as an integral part with the pipe cradle.

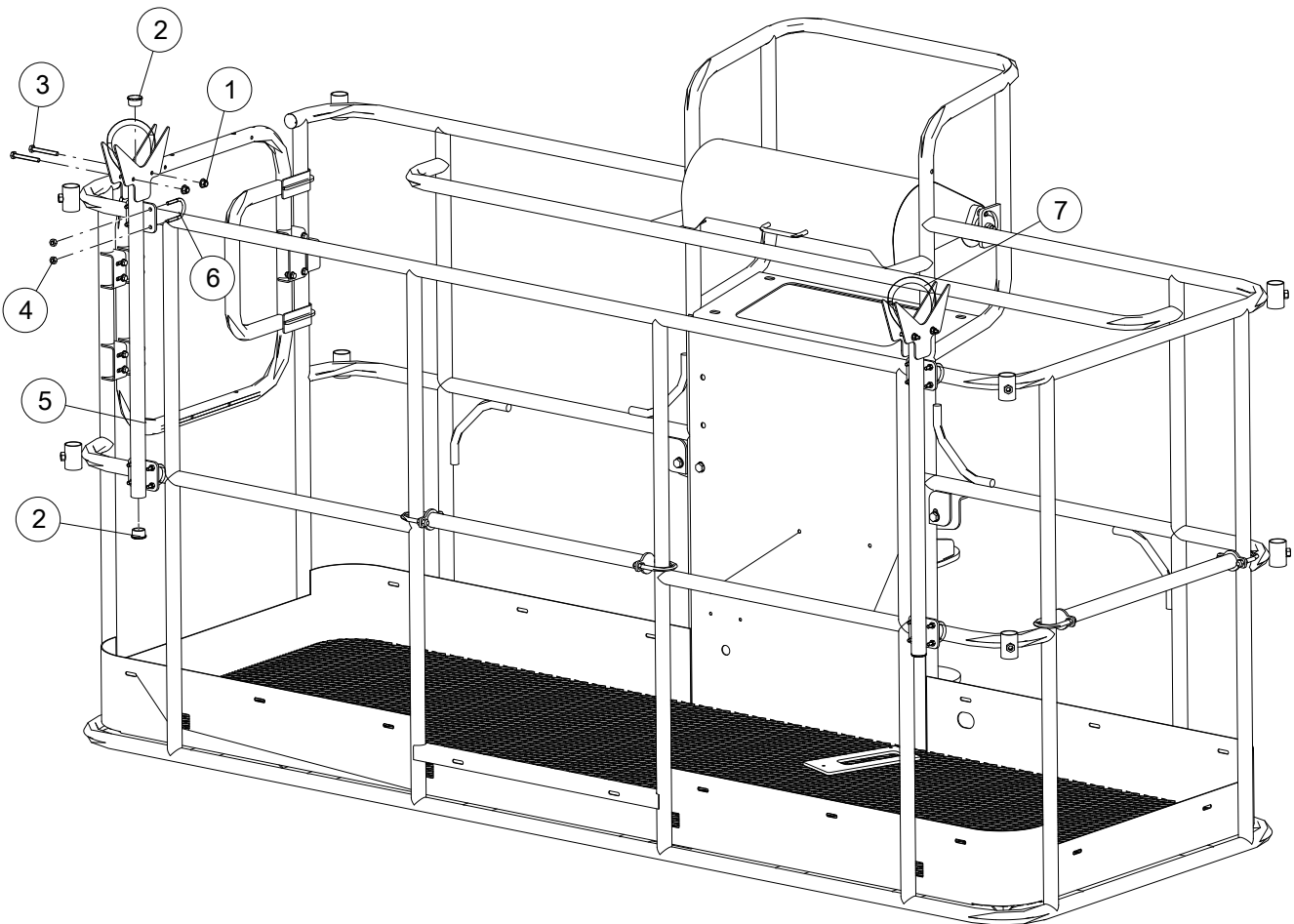

Fig 8

Table 11-5

No.	Part Number	Part Name	Quantity	Comment
1	215030000107	Nut M6-8-ZnD GB/T 6183	4	
2	105064043177	Pipe seal	4	
3	215010000055	Bolt M6×50-A2-70 GB/T 5783	4	
4	215030000004	Nut M6-A2-70 GB/T 6170	18	
5	105064043123	Pipe cradle weldment	1	
6	105064043020	U-bolt	8	
7	\	Strap 400mm*25mm	2	

### Installation and Removal

The pipe cradle assembly includes two pieces of pipe cradles secured with U-bolts and nuts to both sides of the guardrails.

**! WARNING**

**Unsafe Operation Hazard**



Except for designated models and corresponding markets, it is forbidden to install the pipe cradle on products with other models or in other markets than specified.

**! WARNING**

**Unsafe Operation Hazard**



- Read and understand the following safety rules before proceeding to the next step.
- The installation of the pipe cradles shall not obstruct the normal operation of the platform controller.
- The installation of the pipe cradles shall not obstruct the entrance and exit of the platform.
- Before installing the pipe cradles, ensure that the platform remains level.

#### Installation instructions

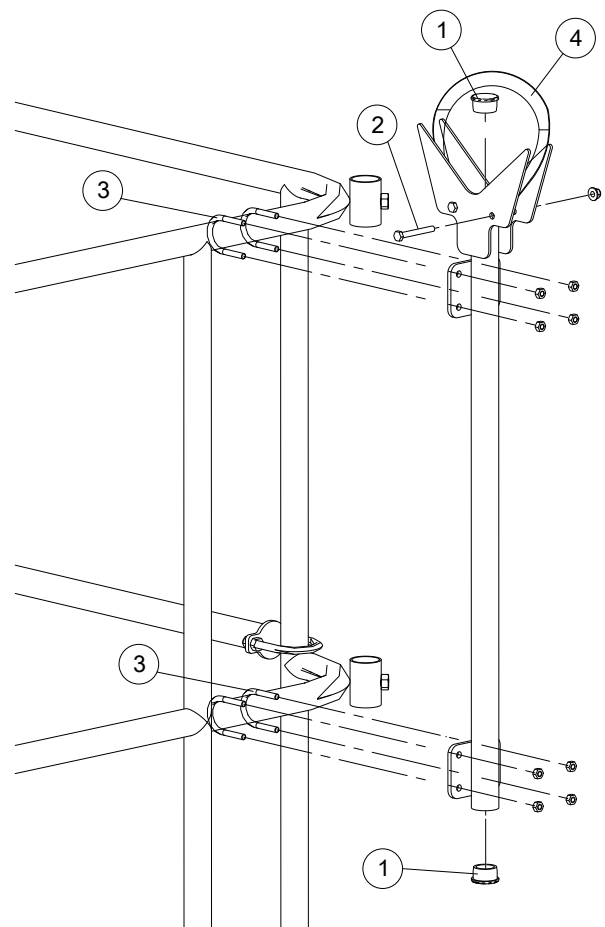

Fig 9

1. Install the top and bottom pipe seals to the pipe cradle weldment.
2. Secure the welding plate on the top of the pipe cradle weldment with bolts.
3. Roughly secure the pipe cradle to one side of the platform, and then tighten the pipe cradle from top to bottom sequentially: insert the U-bolt through the platform guardrails, align it with the mounting holes of the pipe cradle, and then secure it with hex nuts. Install the pipe cradle to the other side of the

platform in the same way.

4. Fasten the strap to tightly secure it to the bracket.

**Removal instructions**

Disassemble the pipe cradles in the reverse order of the installation instructions.

**Instructions for Use**

**WARNING**

**Tipping Hazard**

- The pipe cradle and the load upon will affect the load capacity of the platform, thus must be factored into the total platform capacity.**
- In case of excessive combined weight of the pipe cradle and the load upon, the maximum number of people on the platform should be reduced.**

**Table 11-6**

Pipe cradle capacity	100kg (220lbs)
Pipe cradle assembly weight	6kg (13lbs)

After the pipe cradle is installed, follow the below instructions for use:

1. Ensure that the pipe cradles are installed correctly and secured to the platform.
2. Place the load upon the pipe cradle, and ensure that the load length remains parallel with the pipe cradle length.
3. Ensure the load is centered on the same vertical

plane with the center of the pipe cradle.

4. Use the straps to secure the load to the both pipe cradles.
5. Gently push and pull on the load to ensure that the load is securely secured.
6. When the machine is operating, ensure that the load is always secured in place.

**11.3 PANEL CRADLE**

Self-propelled boom-supported elevating work platforms are designed to transport people, tools and materials to aerial workplaces. When it is needed to transport the panel materials to an aerial position, the panel cradle serves as a supporting unit to hold and secure the panel materials for safe transport.

**WARNING**

**Unsafe Operation Hazard**

- Except for designated models and corresponding markets, it is forbidden to install the panel cradle on products with other models or in other markets than specified.**
- Before using the panel cradle, the safety rules and all operating instructions should be read, understood and observed. This manual should always be kept as an integral part with the panel cradle.**

Parts List

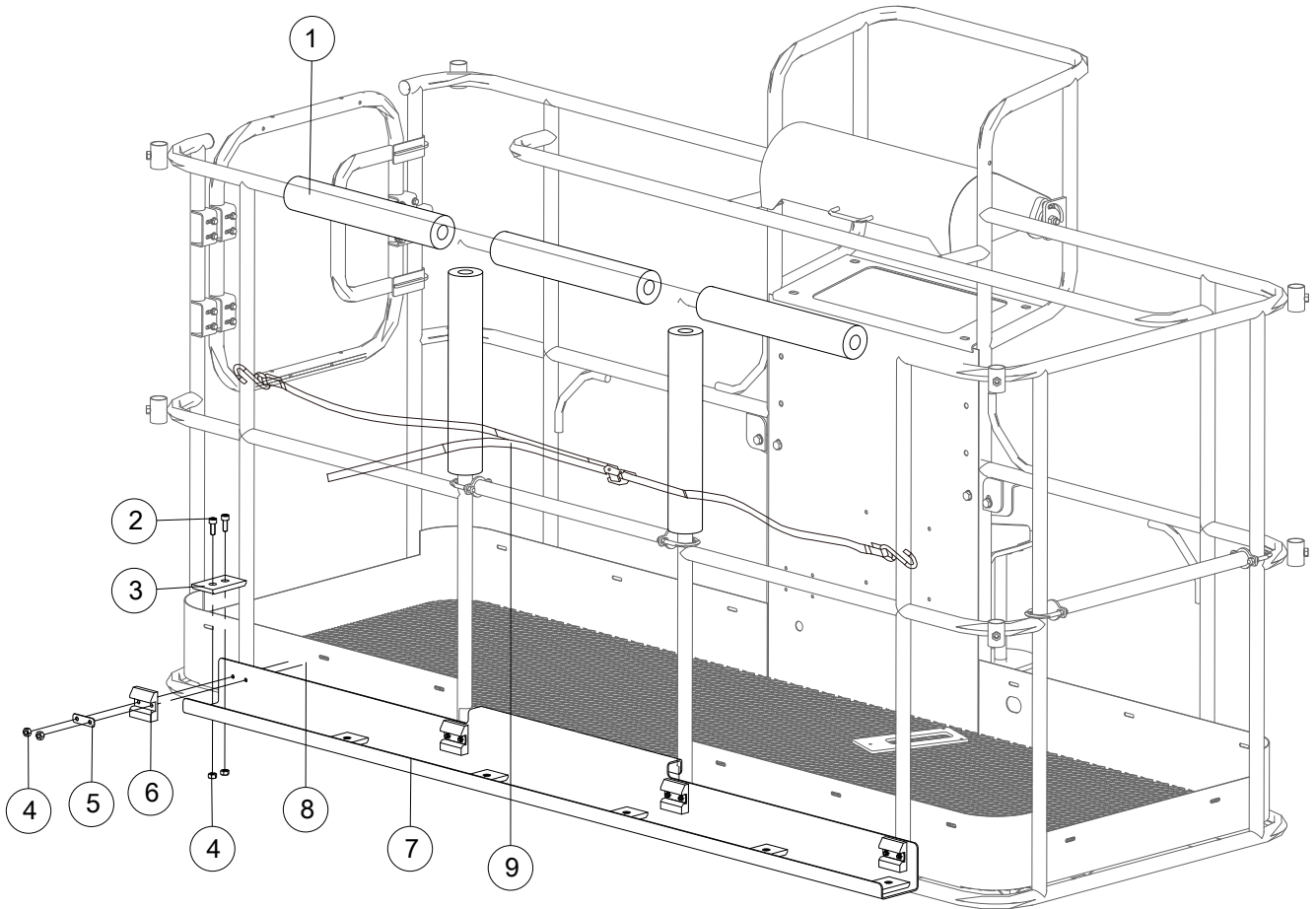

Fig 10

Table 11-7

No.	Part Number	Part Name	Quantity	Comment
1	216030003000	Tube pad	5	
2	215020000011	Screw M6×16-A2-70 GB/T 70.1	12	
3	105064043024	Cushion block	6	
4	215030000004	Nut M6-A2-70 GB/T 6170	20	
5	105064043178	Cushion plate	4	
6	105064043136	Vertical cushion block	4	
7	105064043017	Mounting plate	1	
8	105064043020	U-bolt	4	
9	\	Strap 3000mm*25mm	1	

Installation and Removal

**! WARNING**

**Unsafe Operation Hazard**

**Except for designated models and corresponding markets, it is forbidden to install the panel cradle on products with other models or in**



**! WARNING**

**Unsafe Operation Hazard**  
other markets than specified.

Installation instructions

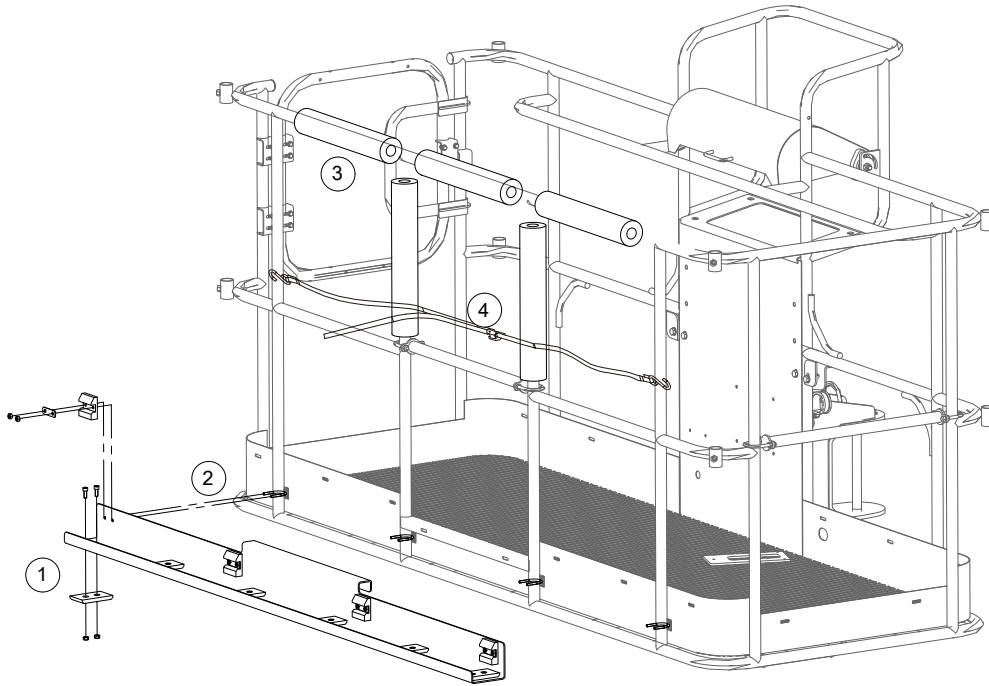



Fig 11

1. Using the bolts and nuts, secure the cushion blocks to the mounting plate of the panel cradle.
2. After roughly securing the mounting plate in place, insert the U-bolt into the holes of the mounting plate and vertical cushion block, and then secure it with the cushion plate and nut. Install other mounting plates sequentially as illustrated.
3. Install the tube pads to the platform guardrails.
4. Attach the straps to the guardrails to secure the mounting plate tightly on the platform.

**Removal instructions**

Disassemble the panel cradle in the reverse order of the installation instructions.

Instructions for Use

 **WARNING**



**Tipping Hazard**

- When the wind speed exceeds 12.5m/s (28mph), do not use the panel cradle.
- The panel cradle and the load upon will affect the load capacity of the platform, thus must be factored into the total platform capacity.
- In case of excessive combined weight of the panel cradle and the load upon, the maximum number of people on the platform should be reduced.
- The panel surface area will expose the machine to an increased load of wind and reduce the stability of the machine.
- Only use the panel cradle when the machine is on flat, solid ground.

Table 11-8

Panel cradle capacity	115kg (253.5lbs)
Panel cradle weight	15.2kg (33.5lbs)
Maximum allowable wind speed	12.5m/s (28mph)
Maximum allowable panel surface area	0.17m <sup>2</sup> (1.83sq.ft)
Maximum allowable panel vertical height	1.2m (3ft 11in)

1. Ensure that the panel cradle is installed correctly and secured to the platform.
2. Place the load upon the panel cradle, and ensure that the load length remains parallel with the panel cradle length.

3. Ensure the load is centered on the same vertical plane with the center of the panel cradle.
4. Use the straps to secure the load to the platform.
5. Gently push and pull on the load to ensure that the load is securely secured.
6. When the machine is operating, ensure that the load is always secured in place.

**NOTICE**



*Ensure that the load remains a proper distance from the door bar to prevent abrasion, crush or other damages to the load.*

11.4 PLATFORM MESH

The platform mesh comes in two types: half mesh and full mesh, which can effectively prevent tools or other materials from dropping off the platform.

 **WARNING**

**Unsafe Operation Hazard**

- Except for designated models and corresponding markets, it is forbidden to install the platform mesh on products with other models or in other markets than specified.
- Before using the platform mesh, the safety rules and all operating instructions should be read, understood and observed. This manual should always be kept as an integral part with the platform mesh.

Parts List

Parts list of half mesh

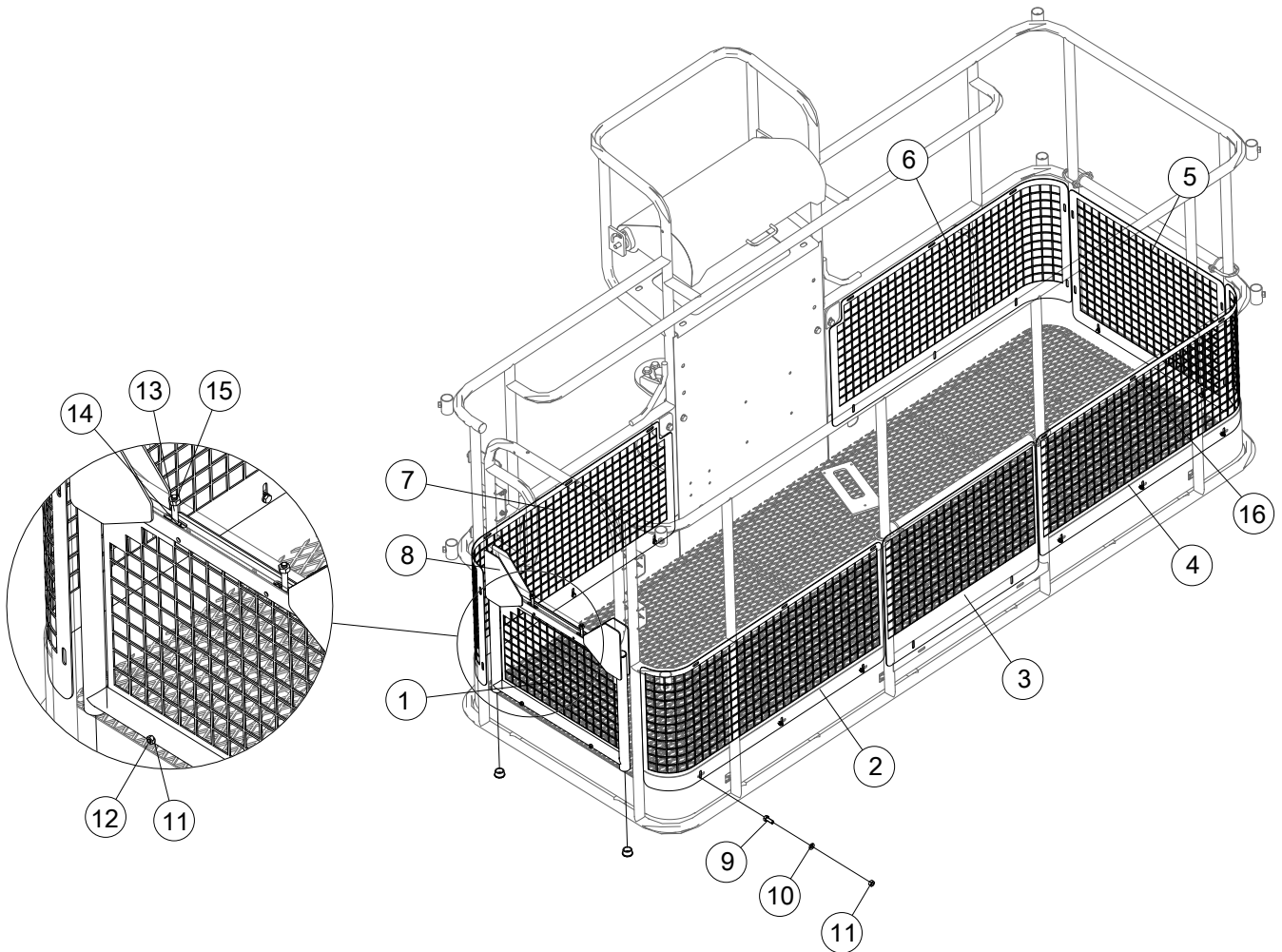

Fig 12

Table 11-9

No.	Part Number	Part Name	Quantity	Comment
1	105064043107	Lower side mesh	1	
2	105064043027	Mesh 1	1	
3	105064043176	Mesh 5	1	
4	105064043175	Mesh 6	1	
5	105064043028	Mesh 2	1	
6	105064043030	Mesh 3	1	
7	105064043031	Mesh 4	1	
8	105064043103	Lower gate frame weldment	1	
9	215010000050	Bolt M6×16-A2-70 GB/T 5783	16	
10	215040000033	Washer 6-A2 GB/T 97.1	18	

Table 11-9 (Continued)

No.	Part Number	Part Name	Quantity	Comment
11	215030000004	Nut M6-A2-70 GB/T 6170	18	
12	215010000054	Bolt M6×40-A2-70 GB/T 5783	2	
13	215010000062	Bolt M8×45-8.8-ZnD GB/T 5783	2	
14	215040000034	Washer 8-200HV-ZnD GB/T 97.1	2	
15	215030000005	Nut M8-8-ZnD GB/T 6170	2	
16	\	Nylon cable tie	\	

Parts list of full mesh

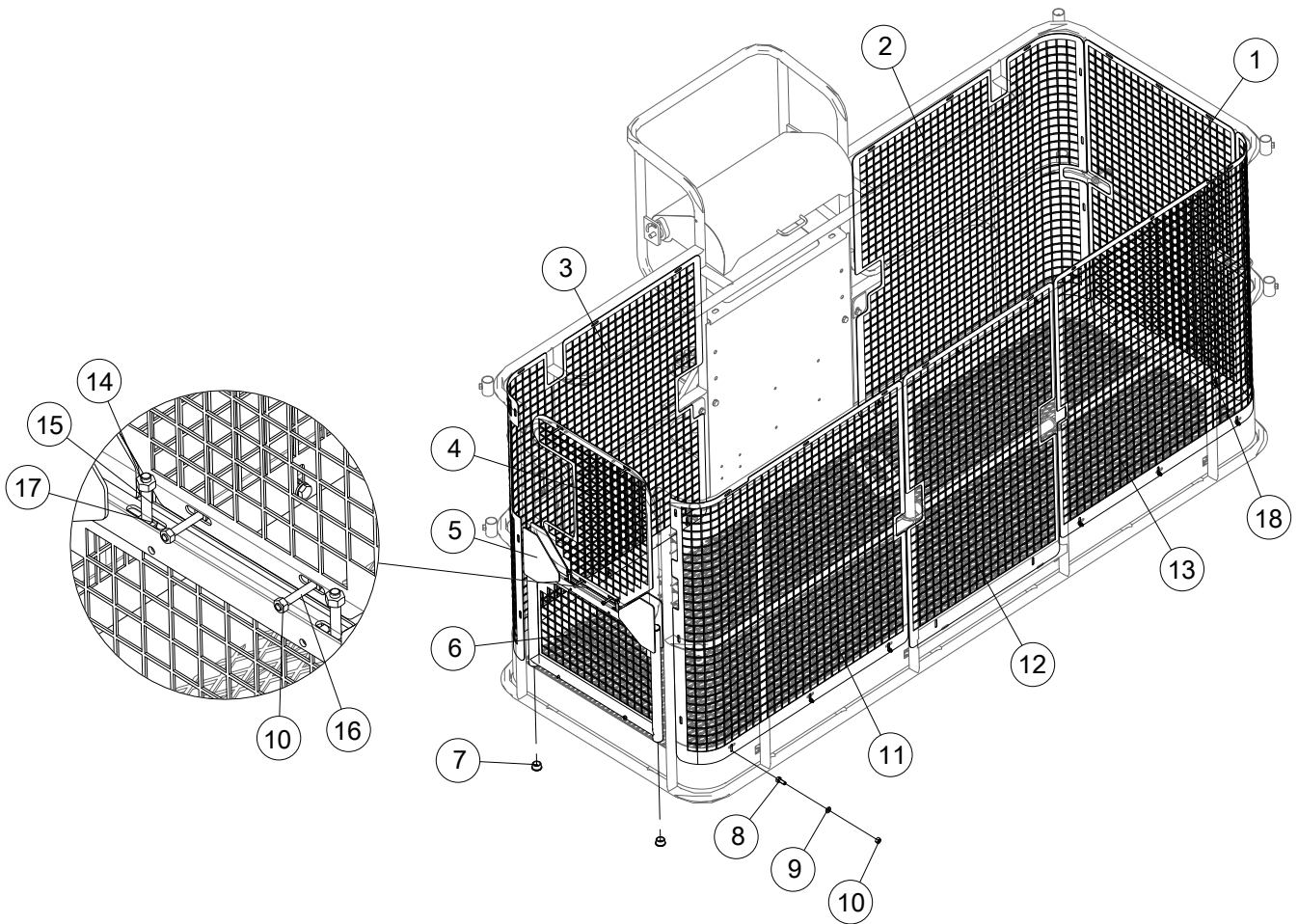

Fig 13

Table 11-10

No.	Part Number	Part Name	Quantity	Comment
1	105064043106	Side mesh	1	
2	105064043109	Front right mesh	1	
3	105064043110	Front left mesh	1	
4	105064043114	Upper side mesh	1	

Table 11-10 (Continued)

No.	Part Number	Part Name	Quantity	Comment
5	105064043103	Lower gate frame weldment	1	
6	105064043107	Lower side mesh	1	
7	105064043177	Pipe seal	4	
8	215010000050	Bolt M6×16-A2-70 GB/T 5783	17	
9	215040000033	Washer 6-A2 GB/T 97.1	23	
10	215030000004	Nut M6-A2-70 GB/T 6170	23	
11	105064043108	Back left mesh	1	
12	105064043112	Back mesh	1	
13	105064043118	Back right mesh	1	
14	215030000005	Nut M8-8-ZnD GB/T 6170	2	
15	215010000062	Bolt M8×45-8.8-ZnD GB/T 5783	2	
16	215010000054	Bolt M6×40-A2-70 GB/T 5783	6	
17	215040000034	Washer 8-200HV-ZnD GB/T 97.1	2	
18	\	Nylon cable tie	\	

Installation and Removal

 **WARNING**

**Unsafe Operation Hazard**



- Except for designated models and corresponding markets, it is forbidden to install the platform mesh on products with other models or in other markets than specified.
- The platform mesh can only be installed on the platform equipped with swing gate.

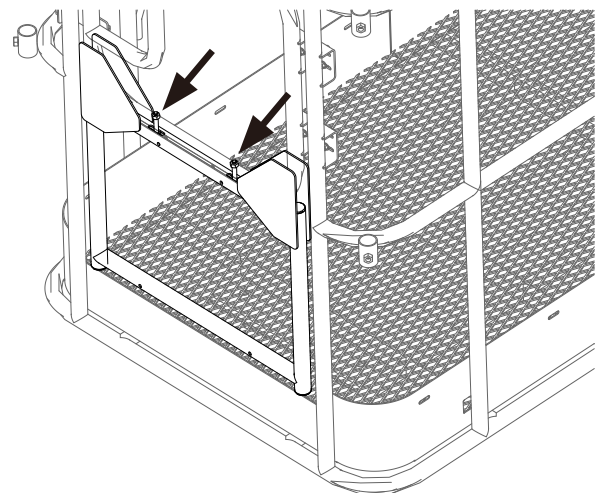

Fig 14

Installation instructions

1. Install the gate frame weldment to the swing gate.
2. Half mesh: Install each mesh in sequence as shown in the figure below, secure the mesh bottom ① with bolts, and secure the mesh top ② and side mesh ③ with nylon cable ties or bolts.

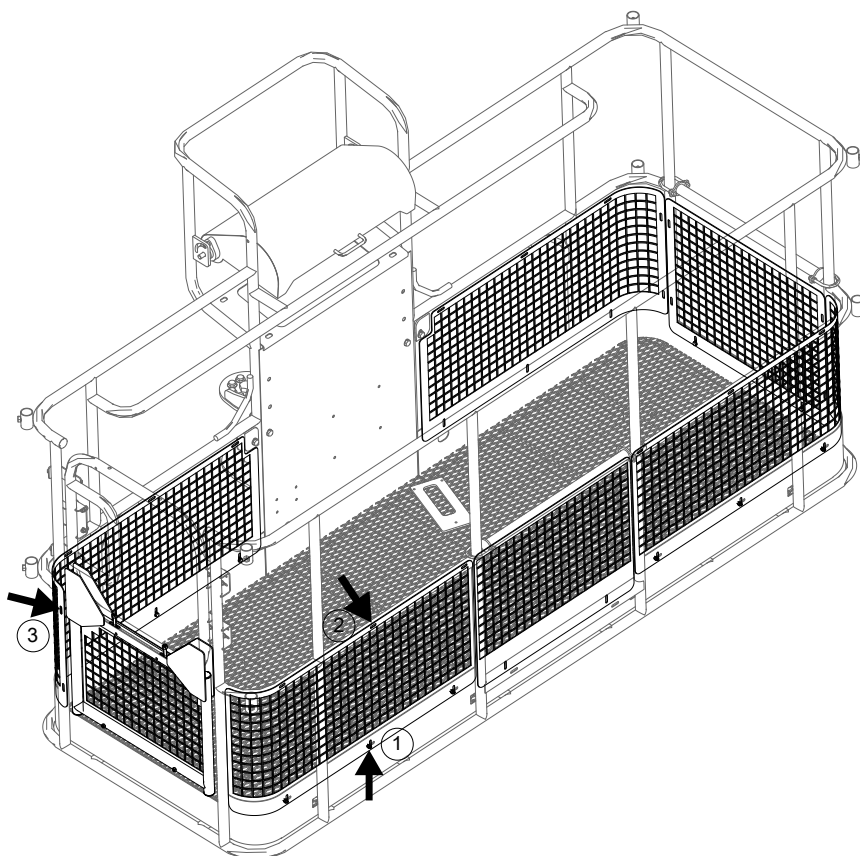

Fig 15

3. Full mesh: Install each mesh in sequence as shown in the figure below, secure the mesh bottom ① with

bolts, and secure the mesh top ② and side mesh ③ with nylon cable ties or bolts.

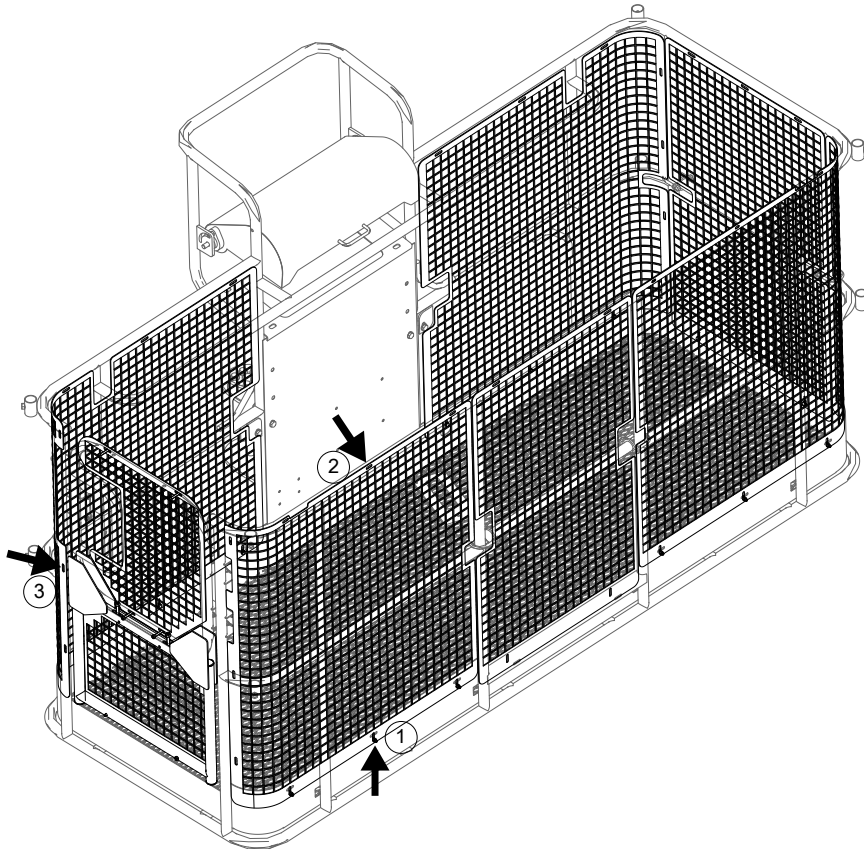

Fig 16

### Removal instructions

Disassemble the platform mesh in the reverse order of the installation instructions.

### Instructions for Use

- After the platform mesh is installed, the operator can only enter or exit the platform via the swing gate.
- Do not install other attachments, such as pipe/panel cradles, to the platform already fitted with platform mesh.

**This Page Intentionally Left Blank**

# Always for Better Access Solutions



## Hunan Sinoboom Intelligent Equipment Co., Ltd.

No.128, East Jinzhou Avenue, Ningxiang High-tech Industrial Park, Changsha, Hunan, China

☎ 0086-0731-87116222 (Sales) & 0086-0731-87116333 (Service)

✉ sales@sinoboom.com

🏠 www.sinoboom.com

---

### North American Subsidiary

Sinoboom North American LLC

310 Mason Creek Drive  
unit #100

Katy, TX 77450, US

Tel: (281) 729-5425

E-mail: info@sinoboom.us

### Europe Subsidiary

Sinoboom B.V.

Nikkelstraat 26, NL-2984 AM Ridderkerk,  
The Netherlands

Tel: +31 180 225 666

E-mail: info@sinoboom.eu

### Korea Subsidiary

Sinoboom Korea Co., Ltd.

95, Docheong-ro, Yeongtong-gu, Suwon-si,  
Gyeonggi-do, Republic of Korea

Tel: 010-8310-8026

E-mail: ka1@sinoboom.com

### Australia Subsidiary

Sinoboom Intelligent Equipment Pty Ltd.

50/358 Clarendon St, South Melbourne VIC  
3205, Australia

E-mail: au@sinoboom.com

### Singapore Subsidiary

Star Access Solutions Pte. Ltd.

112 Robinson Road #03-01 Robinson 112  
Singapore 068902

### Poland Subsidiary

Sinoboom Poland sp. z o.o.

Ul. Bolesława Krzywoustego 74A  
61-144 Poznań, Poland